

---

# EMC Test Report

---

Report No.: AGC05443231019EE01

**PRODUCT DESIGNATION** : Solar powered 20 LED light  
**BRAND NAME** : N/A  
**MODEL NAME** : MO2151  
**APPLICANT** : MID OCEAN BRANDS B.V  
**DATE OF ISSUE** : Oct. 24, 2023  
**STANDARD(S)** : EN IEC 55015:2019+A11:2020  
: EN 61547:2009  
**REPORT VERSION** : V1.0

Attestation of Global Compliance (Shenzhen) Co., Ltd



Any report having not been signed by authorized approver, or having been altered without authorization, or having not been stamped by the "Dedicated Testing/Inspection Stamp" is deemed to be invalid. Copying or excerpting portion of, or altering the content of the report is not permitted without the written authorization of AGC. The test results presented in the report apply only to the tested sample. Any objections to report issued by AGC should be submitted to AGC within 15days after the issuance of the test report. Further enquiry of validity or verification of the test report should be addressed to AGC by [agc01@agccert.com](mailto:agc01@agccert.com).

Attestation of Global Compliance(Shenzhen)Co., Ltd  
Attestation of Global Compliance(Shenzhen)Std & Tech Co., Ltd  
Tel: +86-755 2523 4088 E-mail: [agc@agccert.com](mailto:agc@agccert.com) Web: <http://www.agccert.com/>



### REPORT REVISE RECORD

Report Version	Revise Time	Issued Date	Valid Version	Notes
V1.0	/	Oct. 24, 2023	Valid	Initial release

Any report having not been signed by authorized approver, or having been altered without authorization, or having not been stamped by the "Dedicated Testing/Inspection Stamp" is deemed to be invalid. Copying or excerpting portion of, or altering the content of the report is not permitted without the written authorization of AGC. The test results presented in the report apply only to the tested sample. Any objections to report issued by AGC should be submitted to AGC within 15days after the issuance of the test report. Further enquiry of validity or verification of the test report should be addressed to AGC by [agc01@agccert.com](mailto:agc01@agccert.com).

Attestation of Global Compliance(Shenzhen)Co., Ltd  
Attestation of Global Compliance(Shenzhen)Std & Tech Co., Ltd  
Tel: +86-755 2523 4088 E-mail: [agc@agccert.com](mailto:agc@agccert.com) Web: <http://www.agccert.com/>

**Table of contents**

**1. General information ..... 5**

**2. Description of Test Configuration ..... 6**

    2.1. Technical Description of Product ..... 6

    2.2. Description of Support Equipment ..... 6

    2.3. Description of Test Modes ..... 6

**3. Summary of Measurement Results and Uncertainty ..... 7**

    3.1. Test Specifications ..... 7

    3.2. Description of Measurement Results ..... 7

    3.3. Description of Measurement Uncertainty ..... 9

**4. Test Facility ..... 10**

**5. Measurement of Radiated Emissions at Frequencies up to 1 GHz ..... 11**

    5.1. Requirements ..... 11

    5.2. Block Diagram of Test Setup ..... 11

    5.3. Equipment Details ..... 12

    5.4. Configuration of the EUT and method of measurement ..... 12

    5.5. Test Summary ..... 13

**6. Measurement of Electrostatic discharge ..... 15**

    6.1. Requirements ..... 15

    6.2. Block Diagram of Test Setup ..... 15

    6.3. Equipment Details ..... 16

    6.4. Configuration of the EUT and method of measurement ..... 16

    6.5. Test Summary ..... 17

**7. Measurement of Radio-Frequency Electromagnetic Field ..... 18**

    7.1. Requirements ..... 18

    7.2. Block Diagram of Test Setup ..... 19

    7.3. Equipment Details ..... 20

    7.4. Configuration of the EUT and method of measurement ..... 20

    7.5. Test Summary ..... 21

**8. Measurement of Power-frequency magnetic field ..... 22**

    8.1. Requirements ..... 22

    8.2. Block Diagram of Test Setup ..... 22

    8.3. Equipment Details ..... 23

    8.4. Configuration of the EUT and method of measurement ..... 23

Any report having not been signed by authorized approver, or having been altered without authorization, or having not been stamped by the “Dedicated Testing/Inspection Stamp” is deemed to be invalid. Copying or excerpting portion of, or altering the content of the report is not permitted without the written authorization of AGC. The test results presented in the report apply only to the tested sample. Any objections to report issued by AGC should be submitted to AGC within 15days after the issuance of the test report. Further enquiry of validity or verification of the test report should be addressed to AGC by agc01@agccert.com.

8.5. Test Summary .....24

**9. Photographs of Test Setup .....25**

**10. Photographs of EUT .....27**

Any report having not been signed by authorized approver, or having been altered without authorization, or having not been stamped by the “Dedicated Testing/Inspection Stamp” is deemed to be invalid. Copying or excerpting portion of, or altering the content of the report is not permitted without the written authorization of AGC. The test results presented in the report apply only to the tested sample. Any objections to report issued by AGC should be submitted to AGC within 15days after the issuance of the test report. Further enquiry of validity or verification of the test report should be addressed to AGC by agc01@agccert.com.

### 1. General information

Applicant	MID OCEAN BRANDS B.V
Address	7/F, Kings Tower, 111 King Lam Street, Cheung Sha Wan, Kowloon, Hong Kong
Manufacturer	MID OCEAN BRANDS B.V
Address	7/F, Kings Tower, 111 King Lam Street, Cheung Sha Wan, Kowloon, Hong Kong
Factory	MID OCEAN BRANDS B.V
Address	7/F, Kings Tower, 111 King Lam Street, Cheung Sha Wan, Kowloon, Hong Kong
Product Designation	Solar powered 20 LED light
Brand Name	N/A
Test Model	MO2151
Series Model(s)	N/A
Difference Description	N/A
Deviation from Standard	No any deviation from the test method
Date of receipt of test item	Oct. 17, 2023
Date of Test	Oct. 17, 2023 to Oct. 24, 2023
Test Result	Pass
Test Report Form No	AGCER-EMC-GEN-V1
Note: The test results of this report relate only to the tested sample identified in this report.	

Prepared By   
 Jack Gui  
 (Project Engineer) Oct. 24, 2023

Reviewed By   
 Calvin Liu  
 (Reviewer) Oct. 24, 2023

Approved By   
 Max Zhang  
 (Authorized Officer) Oct. 24, 2023

Any report having not been signed by authorized approver, or having been altered without authorization, or having not been stamped by the “Dedicated Testing/Inspection Stamp” is deemed to be invalid. Copying or excerpting portion of, or altering the content of the report is not permitted without the written authorization of AGC. The test results presented in the report apply only to the tested sample. Any objections to report issued by AGC should be submitted to AGC within 15days after the issuance of the test report. Further enquiry of validity or verification of the test report should be addressed to AGC by agc01@agccert.com.

## 2. Description of Test Configuration

### 2.1. Technical Description of Product

Test arrangements of EUT	Table-top
Hardware Version	N/A
Software Version	N/A
Highest Internal Frequency	Less than 108MHz
EUT Input Rating	DC 1.2V by battery

### Connection Diagram of Host System



### I/O Port Information ( Applicable Not Applicable)

Port Type	Input/Output	Number	Cable Description
--	--	--	--

### 2.2. Description of Support Equipment

Device Type	Manufacturer	Model Name	Serial No.	Data Cable	Power Cable
--	--	--	--	--	--

### 2.3. Description of Test Modes

No.	Test Mode Description	Worst
1	Lighting mode	--

Any report having not been signed by authorized approver, or having been altered without authorization, or having not been stamped by the "Dedicated Testing/Inspection Stamp" is deemed to be invalid. Copying or excerpting portion of, or altering the content of the report is not permitted without the written authorization of AGC. The test results presented in the report apply only to the tested sample. Any objections to report issued by AGC should be submitted to AGC within 15days after the issuance of the test report. Further enquiry of validity or verification of the test report should be addressed to AGC by agc01@agccert.com.

### 3. Summary of Measurement Results and Uncertainty

#### 3.1. Test Specifications

EN 61547:2009	Equipment for general lighting purposes - EMC immunity requirements
EN IEC 55015:2019+A11:2020	Limits and methods of measurement of radio disturbance characteristics of electrical lighting and similar equipment

#### 3.2. Description of Measurement Results

Test items	Test Standard(s)	Verdict
Radiated emissions at frequencies up to 1 GHz	EN IEC 55015	Pass
Electrostatic discharge	IEC 61000-4-2 <sup>a</sup>	Pass
Radio-frequency electromagnetic field	IEC 61000-4-3 <sup>a</sup>	Pass
Power-frequency magnetic field	IEC 61000-4-8 <sup>a</sup>	Pass

Note:

- a. The applicable versions of the basic standards are defined in the standard which listed in the test specification.

Any report having not been signed by authorized approver, or having been altered without authorization, or having not been stamped by the "Dedicated Testing/Inspection Stamp" is deemed to be invalid. Copying or excerpting portion of, or altering the content of the report is not permitted without the written authorization of AGC. The test results presented in the report apply only to the tested sample. Any objections to report issued by AGC should be submitted to AGC within 15days after the issuance of the test report. Further enquiry of validity or verification of the test report should be addressed to AGC by agc01@agccert.com.

Performance table

Performance Criteria for Immunity	
Performance criterion A	During the test, no change of the luminous intensity shall be observed and the regulating control, if any, shall operate during the test as intended.
Performance criterion B	During the test, the luminous intensity may change to any value. After the test, the luminous intensity shall be restored to its initial value within 1 min (30 min for high pressure gas discharge lamps). Regulating controls need not function during the test, but after the test, the mode of the control shall be the same as before the test, provided that during the test no mode changing commands were given.
Performance criterion C	During and after the test, any change of the luminous intensity is allowed and the light source(s) may be extinguished. After the test, within 30 min, all functions shall return to normal, if necessary by temporary interruption of the mains supply and/or operating the regulating control.
The following additional requirement applies to lighting equipment incorporating a starting device: after the test, the lighting equipment is switched off for 30 min and back on again. The lighting equipment shall start and operate as intended.	

Any report having not been signed by authorized approver, or having been altered without authorization, or having not been stamped by the "Dedicated Testing/Inspection Stamp" is deemed to be invalid. Copying or excerpting portion of, or altering the content of the report is not permitted without the written authorization of AGC. The test results presented in the report apply only to the tested sample. Any objections to report issued by AGC should be submitted to AGC within 15days after the issuance of the test report. Further enquiry of validity or verification of the test report should be addressed to AGC by [agc01@agccert.com](mailto:agc01@agccert.com).



### 3.3. Description of Measurement Uncertainty

The reported uncertainty of measurement  $y \pm U$ , where expanded uncertainty  $U$  is based on a standard uncertainty multiplied by a coverage factor of  $k=2$ , providing a level of confidence of approximately 95%.

Item	Measurement Uncertainty
Conducted emissions from the AC mains power ports	$U_c = \pm 2.9$ dB
Radiated emissions at frequencies up to 1 GHz	$U_c = \pm 3.9$ dB
Radiated emissions at frequencies above 1 GHz	$U_c = \pm 4.9$ dB

Any report having not been signed by authorized approver, or having been altered without authorization, or having not been stamped by the "Dedicated Testing/Inspection Stamp" is deemed to be invalid. Copying or excerpting portion of, or altering the content of the report is not permitted without the written authorization of AGC. The test results presented in the report apply only to the tested sample. Any objections to report issued by AGC should be submitted to AGC within 15days after the issuance of the test report. Further enquiry of validity or verification of the test report should be addressed to AGC by [agc01@agccert.com](mailto:agc01@agccert.com).

#### 4. Test Facility

Laboratory name: Attestation of Global Compliance (Shenzhen) Co., Ltd.

Laboratory Address: 1-2/F, Building 19, Junfeng Industrial Park, Chongqing Road, Heping Community, Fuhai Street, Bao'an District, Shenzhen, Guangdong, China

The test facility is recognized, certified, or accredited by the following organizations:

**CNAS-Lab Code: L5488**

Attestation of Global Compliance (Shenzhen) Co., Ltd. is accredited in accordance with the recognized International Standard ISO/IEC 17025 General Requirements for the Competence of Testing and Calibration Laboratories (CNAS-CL01 Accreditation Criteria for Testing and Calibration Laboratories).

**A2LA-Lab Cert. No.: 5054.02**

Attestation of Global Compliance (Shenzhen) Co., Ltd. is accredited in accordance with the recognized International Standard ISO/IEC 17025:2017 General requirements for the competence of testing and calibration laboratories. This laboratory also meets the requirements of any additional program requirements in the Electrical field.

**FCC-Registration No.: 975832**

Attestation of Global Compliance (Shenzhen) Co., Ltd. EMC Laboratory has been registered and fully described in a report filed with the FCC (Federal Communications Commission). The acceptance letter from the FCC is maintained in our files with Registration 975832.

**IC-Registration No.: 24842**

**CAB identifier: CN0063**

Attestation of Global Compliance (Shenzhen) Co., Ltd. EMC Laboratory has been registered and fully described in a report filed with the Certification and Engineering Bureau of Industry Canada. The acceptance letter from the IC is maintained in our files with Registration 24842.

**VCCI Membership No.: 4112**

Attestation of Global Compliance (Shenzhen) Co., Ltd. EMC Laboratory has been registered in accordance with VCCI Council Rules.

VCCI Registration No. C-20098 for conducted emissions at AC main power ports

VCCI Registration No. T-20102 for conducted emissions at telecommunication ports

VCCI Registration No. R-20136 for radiated emissions below 1GHz

VCCI Registration No. G-20132 for radiated emissions above 1GHz

Any report having not been signed by authorized approver, or having been altered without authorization, or having not been stamped by the "Dedicated Testing/Inspection Stamp" is deemed to be invalid. Copying or excerpting portion of, or altering the content of the report is not permitted without the written authorization of AGC. The test results presented in the report apply only to the tested sample. Any objections to report issued by AGC should be submitted to AGC within 15days after the issuance of the test report. Further enquiry of validity or verification of the test report should be addressed to AGC by [agc01@agccert.com](mailto:agc01@agccert.com).

## 5. Measurement of Radiated Emissions at Frequencies up to 1 GHz

### 5.1. Requirements

Requirements for radiated emissions at frequencies up to 1 GHz at 3m distance

Test facility	Detector type/ bandwidth	Frequency Range (MHz)	Limits dB( $\mu$ V/m)	Measurement specifications
SAC	Quasi-peak/ 120kHz	30 to 230	40	Instrumentation: CISPR 16-1-1, Clauses 4, 5 Antennas: CISPR 16-1-4, Clause 4.5 Test Site: CISPR 16-1-4, Clause 6 Method: CISPR 16-2-3, Clause 7.6
		230 to 1000	47	

**Note:**

- The lower limit shall apply at the transition frequency.

### 5.2. Block Diagram of Test Setup

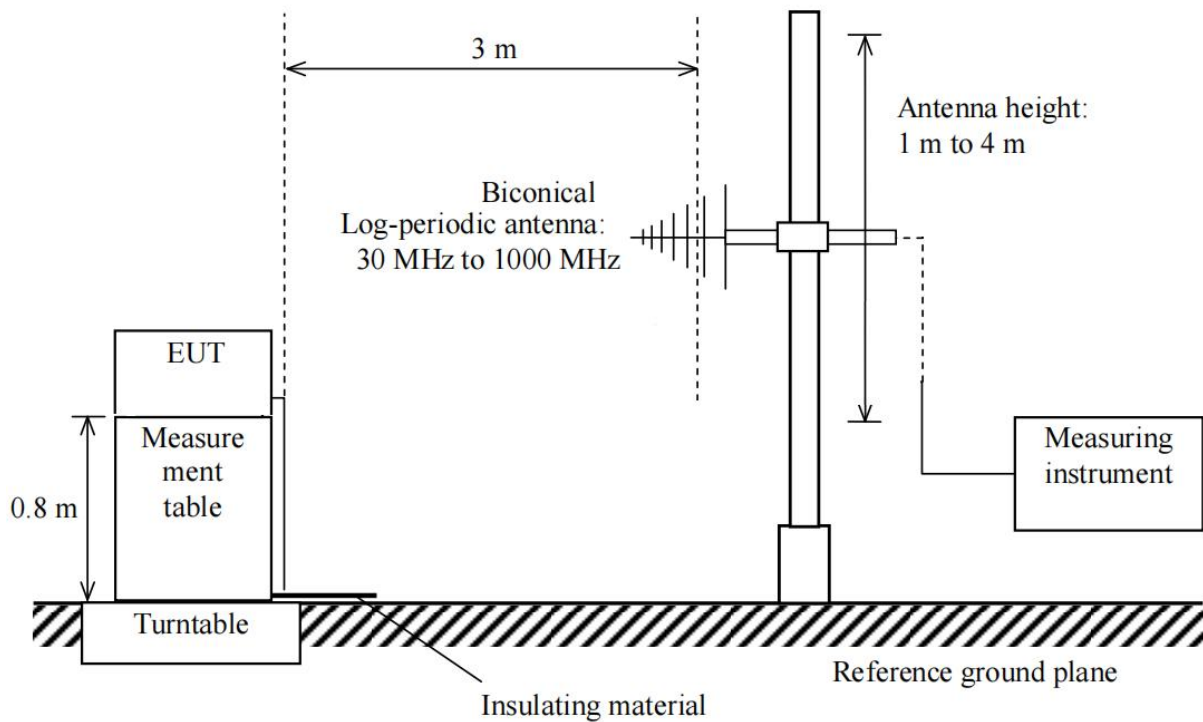

Any report having not been signed by authorized approver, or having been altered without authorization, or having not been stamped by the "Dedicated Testing/Inspection Stamp" is deemed to be invalid. Copying or excerpting portion of, or altering the content of the report is not permitted without the written authorization of AGC. The test results presented in the report apply only to the tested sample. Any objections to report issued by AGC should be submitted to AGC within 15 days after the issuance of the test report. Further enquiry of validity or verification of the test report should be addressed to AGC by agc01@agccert.com.

### 5.3. Equipment Details

#### Measuring Instruments

Instruments	Manufacturer	Model	S/N	Cal. Date	Cal. Due
Test Receiver	R&S	ESCI	10096	Feb. 18, 2023	Feb. 17, 2024
Antenna	SCHWARZBECK	VULB9168	D69250	May 11, 2023	May 10, 2025

#### Measuring Software

Software Name	Manufacturer	Details
EZ-EMC	FARA	For EMC Measurement, Version RA-03A

### 5.4. Configuration of the EUT and method of measurement

- a. The EUT was set up as per the test configuration to simulate typical actual usage per the user's manual. When the EUT is a tabletop system, the EUT was placed on the top surface of a measurement table, 0.8 m high from the horizontal reference plane. When the EUT is a floor-standing equipment, it is placed on the ground plane which has a 10 cm non-conductive covering to insulate the EUT from the ground plane.
- b. Support equipment, if needed, was placed as per CISPR 16-2-3.
- c. All I/O cables were positioned to simulate typical actual usage as per CISPR 16-2-3.
- d. The maximum receiving level of radiated emissions from the EUT was measured while the turntable was rotated from 0° to 360° and the antenna height was scanned between 1 m and 4 m. The cables were laid out to attain the maximum level of radiated emissions.
- e. The more description of the tests, the test methods, and the test set-ups are given in the applicable test standard.
- f. Record at least six highest emissions relative to the limits at each frequency of interest unless the emission is 10 dB or greater below the limit.
- g. A radiated emission is calculated by the following equation:
  - Measurement Level dB(μV/m) = Receiver reading dB(μV) + Factor(dB/m)
  - Factor(dB/m) = Antenna Factor(dB/m) + Cable Loss(dB)
  - Margin= Limit-Level

Any report having not been signed by authorized approver, or having been altered without authorization, or having not been stamped by the "Dedicated Testing/Inspection Stamp" is deemed to be invalid. Copying or excerpting portion of, or altering the content of the report is not permitted without the written authorization of AGC. The test results presented in the report apply only to the tested sample. Any objections to report issued by AGC should be submitted to AGC within 15days after the issuance of the test report. Further enquiry of validity or verification of the test report should be addressed to AGC by agc01@agccert.com.

### 5.5. Test Summary

Test Engineer	Linke	Temperature	22.8 °C
Test Date	Oct. 19, 2023	Air Pressure	985 Mbar
Worst Mode	Mode 1	Relative Humidity	58.7 %
Verdict	Pass		

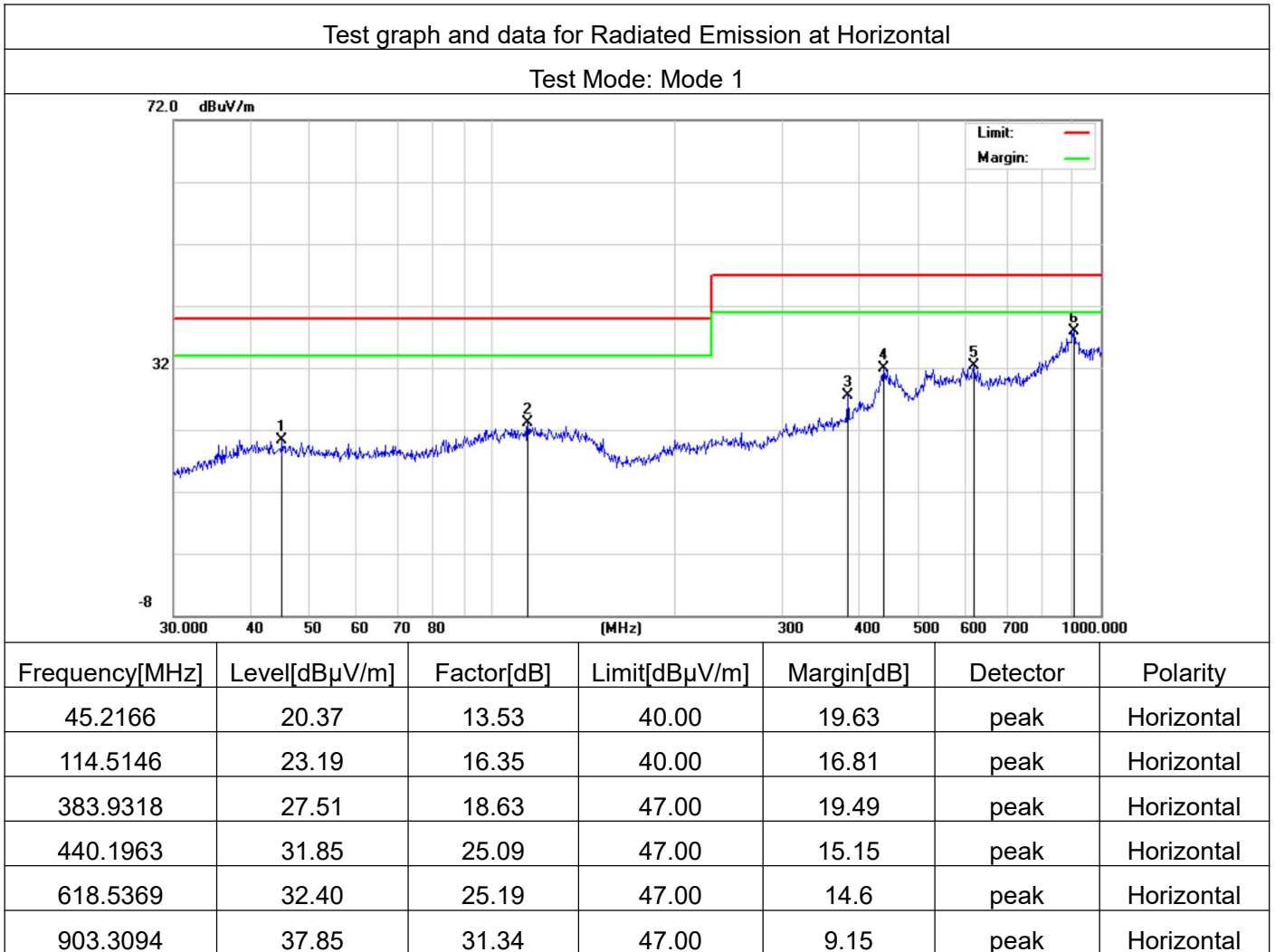

Any report having not been signed by authorized approver, or having been altered without authorization, or having not been stamped by the "Dedicated Testing/Inspection Stamp" is deemed to be invalid. Copying or excerpting portion of, or altering the content of the report is not permitted without the written authorization of AGC. The test results presented in the report apply only to the tested sample. Any objections to report issued by AGC should be submitted to AGC within 15days after the issuance of the test report. Further enquiry of validity or verification of the test report should be addressed to AGC by agc01@agccert.com.

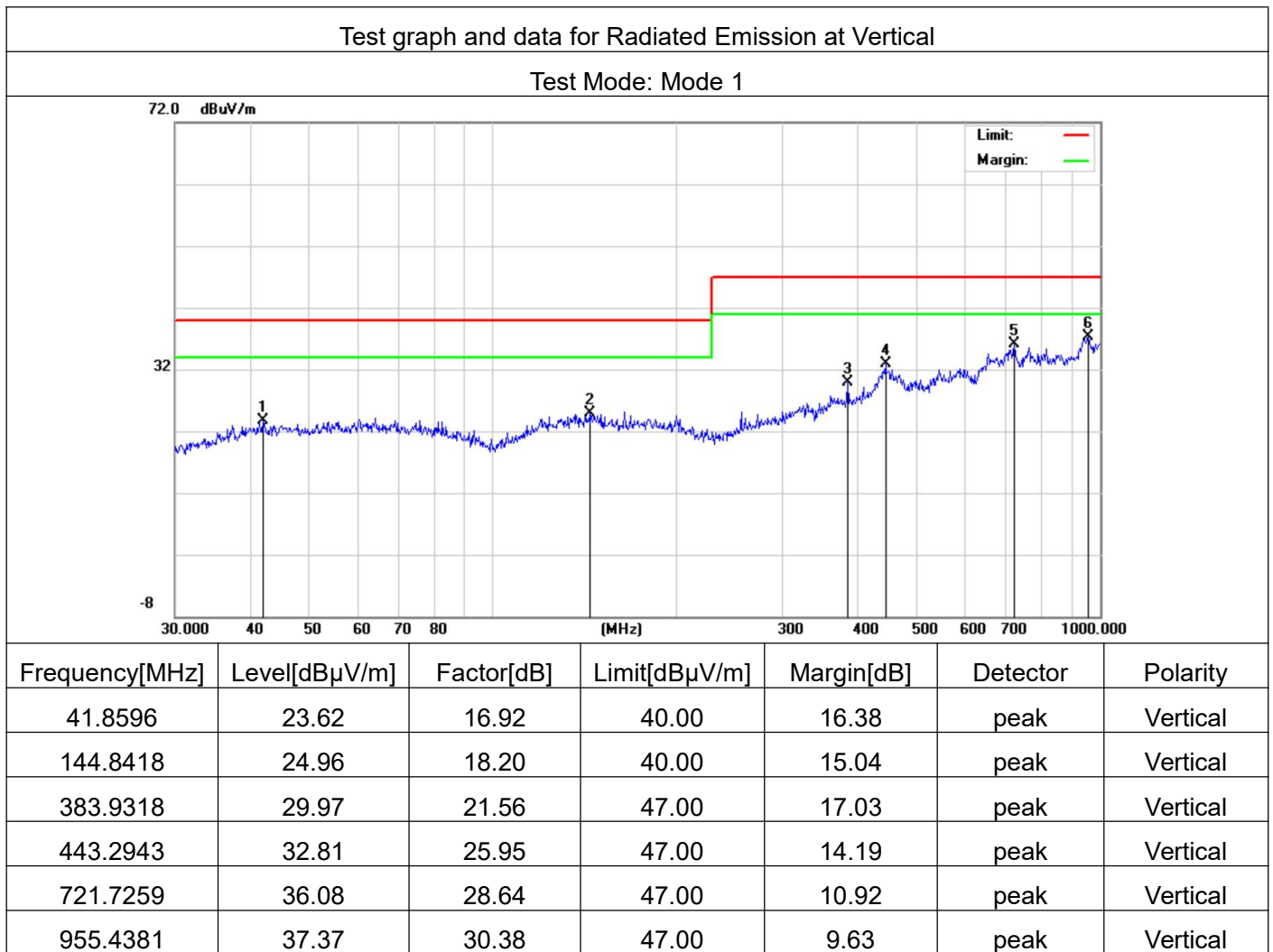

Any report having not been signed by authorized approver, or having been altered without authorization, or having not been stamped by the "Dedicated Testing/Inspection Stamp" is deemed to be invalid. Copying or excerpting portion of, or altering the content of the report is not permitted without the written authorization of AGC. The test results presented in the report apply only to the tested sample. Any objections to report issued by AGC should be submitted to AGC within 15days after the issuance of the test report. Further enquiry of validity or verification of the test report should be addressed to AGC by agc01@agccert.com.

## 6. Measurement of Electrostatic discharge

### 6.1. Requirements

Port	Enclosure
Basic Standard	IEC 61000-4-2
Test Level	±8.0 kV (Air Discharge) ±4.0 kV (Contact Discharge) ±4.0 kV (Indirect Discharge)
Required Performance Criterion	B
Time Between Each Discharge:	1 second
Number of Discharge for Each Applied Voltage	10

### 6.2. Block Diagram of Test Setup

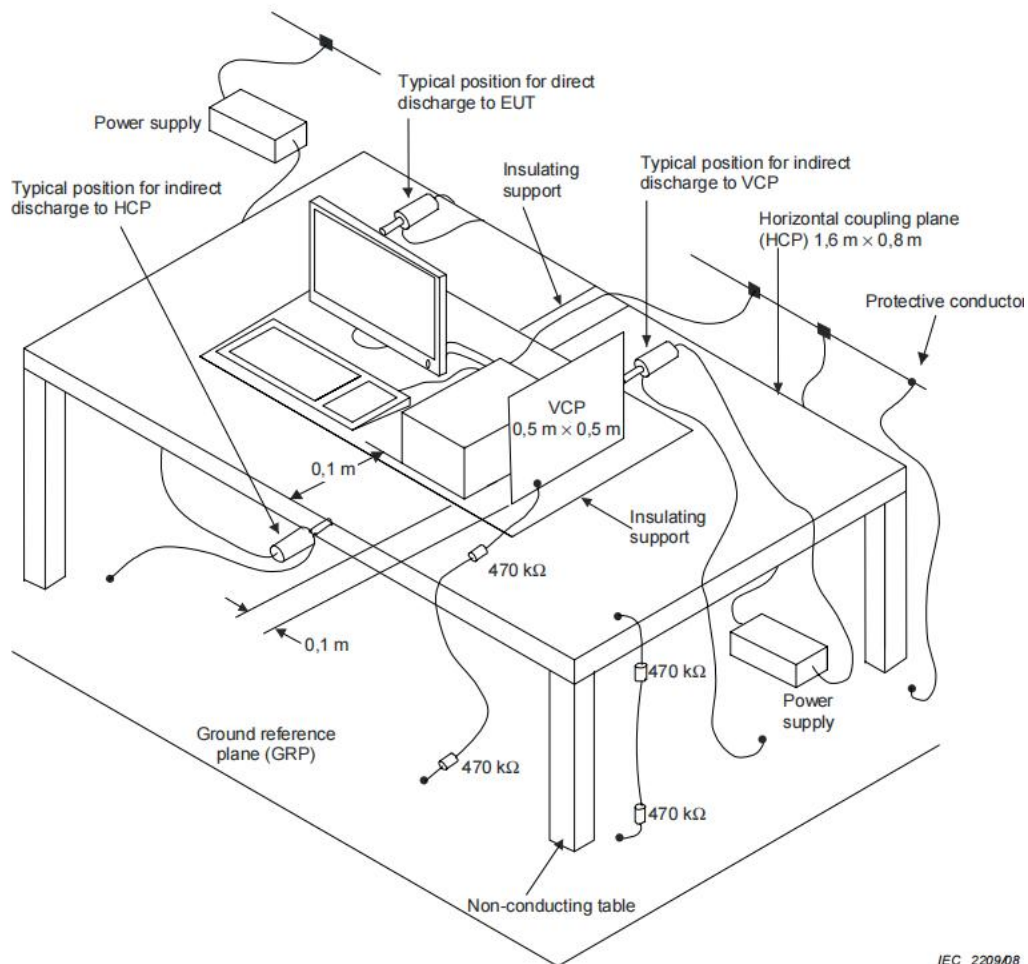

Any report having not been signed by authorized approver, or having been altered without authorization, or having not been stamped by the “Dedicated Testing/Inspection Stamp” is deemed to be invalid. Copying or excerpting portion of, or altering the content of the report is not permitted without the written authorization of AGC. The test results presented in the report apply only to the tested sample. Any objections to report issued by AGC should be submitted to AGC within 15 days after the issuance of the test report. Further enquiry of validity or verification of the test report should be addressed to AGC by agc01@agccert.com.

### 6.3. Equipment Details

#### Measuring Instruments

Instruments	Manufacturer	Model	S/N	Cal. Date	Cal. Due
ESD Simulator	Schaffner	NSG 438	782	Dec. 30, 2022	Dec. 29, 2023

#### Measuring Software

Software Name	Manufacturer	Details
--	--	--

### 6.4. Configuration of the EUT and method of measurement

- a. Electrostatic discharges were applied only to those points and surfaces of the EUT that are accessible to users during normal operation.
- b. The test was performed with at least ten single discharges on the pre-selected points in the most sensitive polarity.
- c. The time interval between two successive single discharges was at least 1 second.
- d. The ESD generator was held perpendicularly to the surface to which the discharge was applied and the return cable was at least 0.2 meters from the EUT.
- e. Contact discharges were applied to the non-insulating coating, with the pointed tip of the generator penetrating the coating and contacting the conducting substrate.
- f. Air discharges were applied with the round discharge tip of the discharge electrode approaching the EUT as fast as possible (without causing mechanical damage) to touch the EUT. After each discharge, the ESD generator was removed from the EUT and re-triggered for a new single discharge. The test was repeated until all discharges were completed.
- g. At least ten single discharges (in the most sensitive polarity) were applied to the Horizontal Coupling Plane at points on each side of the EUT. The ESD generator was positioned vertically at a distance of 0.1 meters from the EUT with the discharge electrode touching the HCP.
- h. At least ten single discharges (in the most sensitive polarity) were applied to the center of one vertical edge of the Vertical Coupling Plane in sufficiently different positions that the four faces of the EUT were completely illuminated. The VCP (dimensions 0.5m×0.5m) was placed vertically to and 0.1 meters from the EUT.
- i. The test results shall be classified in terms of the loss of function or degradation of performance of the equipment under test, relative to a performance criterion defined in the report.

Any report having not been signed by authorized approver, or having been altered without authorization, or having not been stamped by the "Dedicated Testing/Inspection Stamp" is deemed to be invalid. Copying or excerpting portion of, or altering the content of the report is not permitted without the written authorization of AGC. The test results presented in the report apply only to the tested sample. Any objections to report issued by AGC should be submitted to AGC within 15days after the issuance of the test report. Further enquiry of validity or verification of the test report should be addressed to AGC by agc01@agccert.com.



### 6.5. Test Summary

Test Engineer	Sam	Temperature	24 °C
Test Date	Oct. 20, 2023	Air Pressure	985 Mbar
Test Mode(s)	Mode 1	Relative Humidity	44 %
Verdict	Pass		

Voltage	Coupling	Observation	Performance
±4kV	Contact Discharge	No degradation of performance	N/A
±2KV, ±4kV, ±8kV	Air Discharge	No degradation of performance	A
±4kV	Indirect Discharge HCP	No degradation of performance	A
±4kV	Indirect Discharge VCP	No degradation of performance	A

Blue line: Air discharge



Note: Contact discharge point not found.

Any report having not been signed by authorized approver, or having been altered without authorization, or having not been stamped by the “Dedicated Testing/Inspection Stamp” is deemed to be invalid. Copying or excerpting portion of, or altering the content of the report is not permitted without the written authorization of AGC. The test results presented in the report apply only to the tested sample. Any objections to report issued by AGC should be submitted to AGC within 15days after the issuance of the test report. Further enquiry of validity or verification of the test report should be addressed to AGC by agc01@agccert.com.

## 7. Measurement of Radio-Frequency Electromagnetic Field

### 7.1. Requirements

Port	Enclosure
Basic Standard	IEC 61000-4-3
Required Performance Criterion	A
Test Level	3V/m with 80% AM. 1kHz Modulation at 80 to 1000MHz
Antenna polarization	Vertical and Horizontal
Step size increment <sup>a</sup>	1%
Dwell time <sup>b</sup>	≤ 5 seconds
Test Distance	3m
EUT position facing antenna	Front side, back side, left side and right side

Notes:

- a. Recognizing that a 1% step size is preferred, the frequency range can be swept incrementally with a step size not exceeding 4% of the previous frequency with a test level of twice the value of the specified test level in order to reduce the testing time for equipment requiring testing in multiple configurations and/or long cycle times.
- b. The dwell time at each frequency shall not be less than the time necessary for the EUT to be exercised and to be able to respond. However, the dwell time shall not exceed 5 seconds at each of the frequencies during the scan. The time to exercise the EUT is not interpreted as a total time of a program or a cycle but related to the reaction time in case of failure of the EUT.

Any report having not been signed by authorized approver, or having been altered without authorization, or having not been stamped by the “Dedicated Testing/Inspection Stamp” is deemed to be invalid. Copying or excerpting portion of, or altering the content of the report is not permitted without the written authorization of AGC. The test results presented in the report apply only to the tested sample. Any objections to report issued by AGC should be submitted to AGC within 15days after the issuance of the test report. Further enquiry of validity or verification of the test report should be addressed to AGC by agc01@agccert.com.

## 7.2. Block Diagram of Test Setup

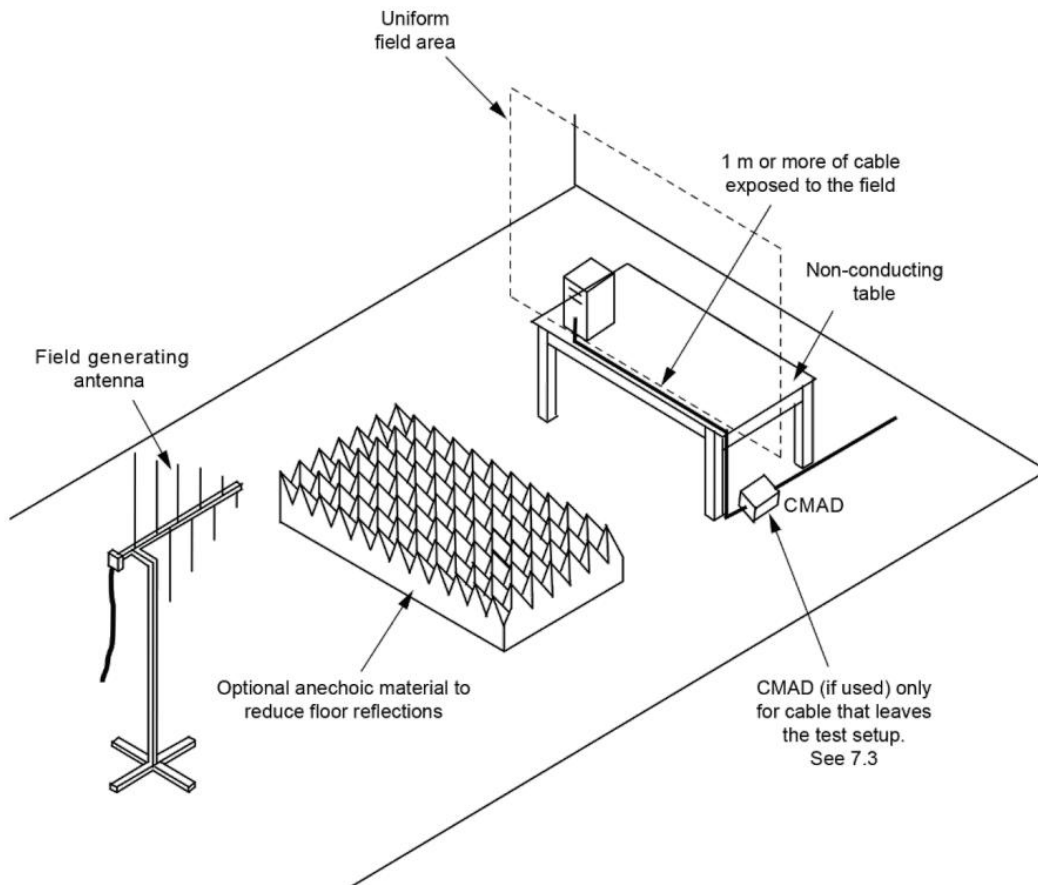

Any report having not been signed by authorized approver, or having been altered without authorization, or having not been stamped by the "Dedicated Testing/Inspection Stamp" is deemed to be invalid. Copying or excerpting portion of, or altering the content of the report is not permitted without the written authorization of AGC. The test results presented in the report apply only to the tested sample. Any objections to report issued by AGC should be submitted to AGC within 15days after the issuance of the test report. Further enquiry of validity or verification of the test report should be addressed to AGC by [agc01@agccert.com](mailto:agc01@agccert.com).

### 7.3. Equipment Details

#### Measuring Instruments

Instruments	Manufacturer	Model	S/N	Cal. Date	Cal. Due
Signal Generator	Aglient	N5182A	MY50140530	Feb. 17, 2023	Feb. 16, 2024
Directional coupler	Werlatone	C5571-10	99463	Mar. 10, 2022	Mar. 09, 2024
Directional coupler	Werlatone	C5571-10	99482	Mar. 10, 2022	Mar. 09, 2024
Power Amplifier	KALMUS	7100LC	04-02/17-06-001	N/A	N/A
Power Amplifier	Milmega	AS0104-55_55	1004793	N/A	N/A
Power amplifier	rflight	NTWPA-2560100	17063183	N/A	N/A
Wideband Antenna	ETS	3142C	00060447	N/A	N/A

#### Measuring Software

Software Name	Manufacturer	Details
TS+[JS35-RS]	Tonscend	For EMC measurement, version 2.0.1.8

### 7.4. Configuration of the EUT and method of measurement

- a. The Equipment Under Test (EUT) was positioned within the Uniform Field Area (UFA) on a supporting table, ensuring a 3-meter separation from the transmitting antenna. This setup aligns with the calibrated square area, guaranteeing field uniformity during testing. The supporting units were strategically located outside the UFA to avoid any potential interference. Nonetheless, the cables connected to the EUT were intentionally exposed to the precisely calibrated field within the UFA.
- b. Before testing, it will verify the proper operation of the test equipment/system. This verification will involve measuring the field strength at one point within the Uniform Field Area (UFA) at various frequencies.
- c. The test shall be performed according to the above requirements and block diagram which shall specify the test setup.
- d. The test results shall be classified in terms of the loss of function or degradation of performance of the equipment under test, relative to a performance criterion defined in the report.

Any report having not been signed by authorized approver, or having been altered without authorization, or having not been stamped by the "Dedicated Testing/Inspection Stamp" is deemed to be invalid. Copying or excerpting portion of, or altering the content of the report is not permitted without the written authorization of AGC. The test results presented in the report apply only to the tested sample. Any objections to report issued by AGC should be submitted to AGC within 15days after the issuance of the test report. Further enquiry of validity or verification of the test report should be addressed to AGC by agc01@agccert.com.

### 7.5. Test Summary

Test Engineer	Linke	Temperature	23.8 °C
Test Date	Oct. 19, 2023	Air Pressure	985 Mbar
Test Mode(s)	Mode 1	Relative Humidity	60.1 %
Verdict	Pass		

Frequency	Exposed Side	Field Strength (V/m)	Observation	Performance
80MHz to 1GHz	Front	3V/m (rms)	No degradation of performance	A
	Left		No degradation of performance	A
	Rear		No degradation of performance	A
	Right		No degradation of performance	A

Any report having not been signed by authorized approver, or having been altered without authorization, or having not been stamped by the "Dedicated Testing/Inspection Stamp" is deemed to be invalid. Copying or excerpting portion of, or altering the content of the report is not permitted without the written authorization of AGC. The test results presented in the report apply only to the tested sample. Any objections to report issued by AGC should be submitted to AGC within 15days after the issuance of the test report. Further enquiry of validity or verification of the test report should be addressed to AGC by agc01@agccert.com.

## 8. Measurement of Power-frequency magnetic field

### 8.1. Requirements

Port	Enclosure
Basic Standard	IEC 61000-4-8
Test Level	3 A/m
Frequency	50 or 60 Hz
Required Performance Criterion	A
Application of the magnetic field	Continuous

### 8.2. Block Diagram of Test Setup

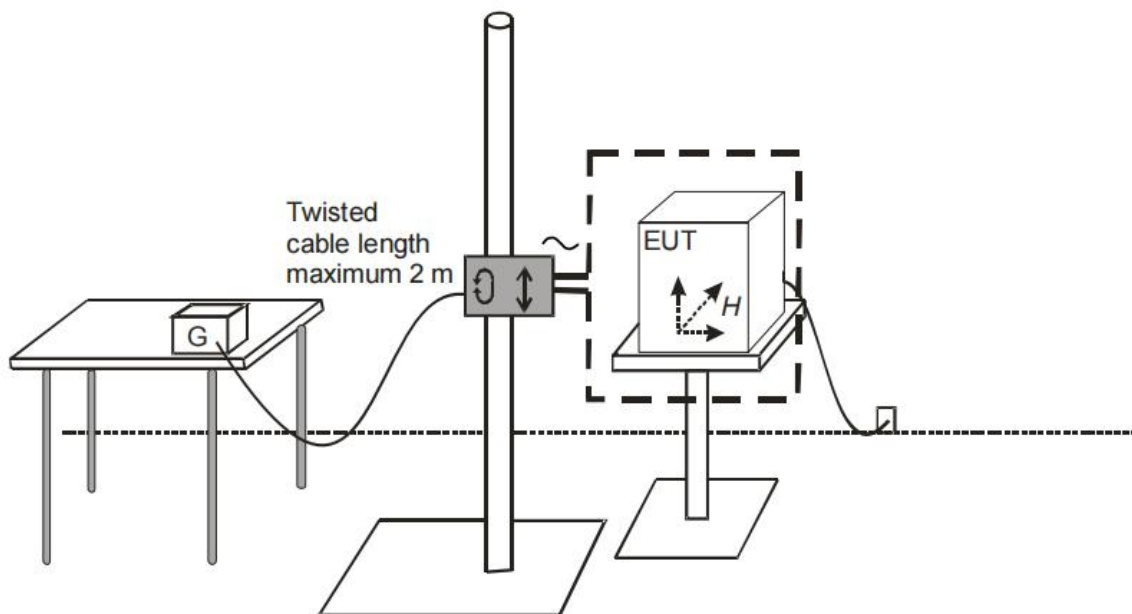

Any report having not been signed by authorized approver, or having been altered without authorization, or having not been stamped by the “Dedicated Testing/Inspection Stamp” is deemed to be invalid. Copying or excerpting portion of, or altering the content of the report is not permitted without the written authorization of AGC. The test results presented in the report apply only to the tested sample. Any objections to report issued by AGC should be submitted to AGC within 15days after the issuance of the test report. Further enquiry of validity or verification of the test report should be addressed to AGC by agc01@agccert.com.

### 8.3. Equipment Details

#### Measuring Instruments

Instruments	Manufacturer	Model	S/N	Cal. Date	Cal. Due
Power frequency field immunity device with coil	HTEC	HPFMF	161701	Jun. 01, 2023	May 31, 2024

#### Measuring Software

Software Name	Manufacturer	Details
--	--	--

### 8.4. Configuration of the EUT and method of measurement

- a. The test shall be performed according to the above requirements and block diagram which shall specify the test setup.
- b. The power supply, signal and other functional electrical quantities shall be applied within their rated range.
- c. If the actual operating signals are not available, they may be simulated.
- d. Preliminary verification of equipment performances shall be carried out prior to applying the test magnetic field.
- e. The plane of the inductive coil shall then be rotated by 90° in order to expose the EUT to the test field with different orientations and the same procedure.
- f. The test results shall be classified in terms of the loss of function or degradation of performance of the equipment under test, relative to a performance criterion defined in the report.

Any report having not been signed by authorized approver, or having been altered without authorization, or having not been stamped by the "Dedicated Testing/Inspection Stamp" is deemed to be invalid. Copying or excerpting portion of, or altering the content of the report is not permitted without the written authorization of AGC. The test results presented in the report apply only to the tested sample. Any objections to report issued by AGC should be submitted to AGC within 15days after the issuance of the test report. Further enquiry of validity or verification of the test report should be addressed to AGC by agc01@agccert.com.

### 8.5. Test Summary

Test Engineer	Sam	Temperature	24 °C
Test Date	Oct. 20, 2023	Air Pressure	985 Mbar
Test Mode(s)	Mode 1	Relative Humidity	45 %
Verdict	Pass		

Frequency	Test Level	Observation	Performance
50Hz	3A/m	No degradation of performance	A

Any report having not been signed by authorized approver, or having been altered without authorization, or having not been stamped by the "Dedicated Testing/Inspection Stamp" is deemed to be invalid. Copying or excerpting portion of, or altering the content of the report is not permitted without the written authorization of AGC. The test results presented in the report apply only to the tested sample. Any objections to report issued by AGC should be submitted to AGC within 15days after the issuance of the test report. Further enquiry of validity or verification of the test report should be addressed to AGC by [agc01@agccert.com](mailto:agc01@agccert.com).



## 9. Photographs of Test Setup

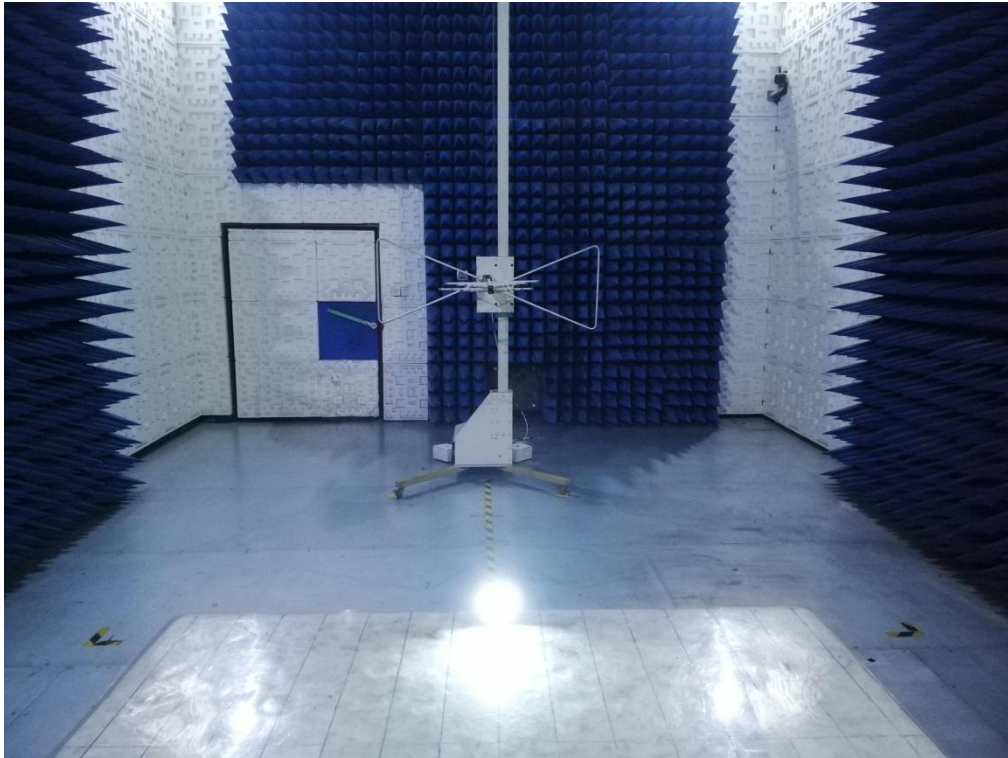

Radiated emissions at frequencies up to 1 GHz

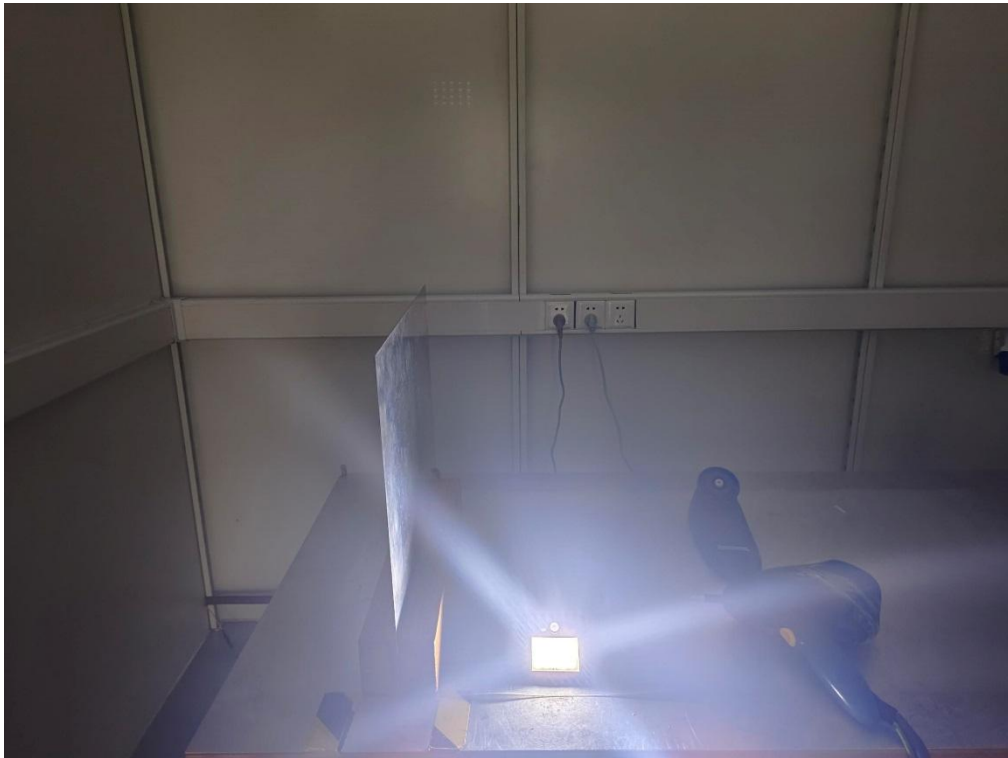

Electrostatic discharge

Any report having not been signed by authorized approver, or having been altered without authorization, or having not been stamped by the “Dedicated Testing/Inspection Stamp” is deemed to be invalid. Copying or excerpting portion of, or altering the content of the report is not permitted without the written authorization of AGC. The test results presented in the report apply only to the tested sample. Any objections to report issued by AGC should be submitted to AGC within 15days after the issuance of the test report. Further enquiry of validity or verification of the test report should be addressed to AGC by [agc01@agccert.com](mailto:agc01@agccert.com).

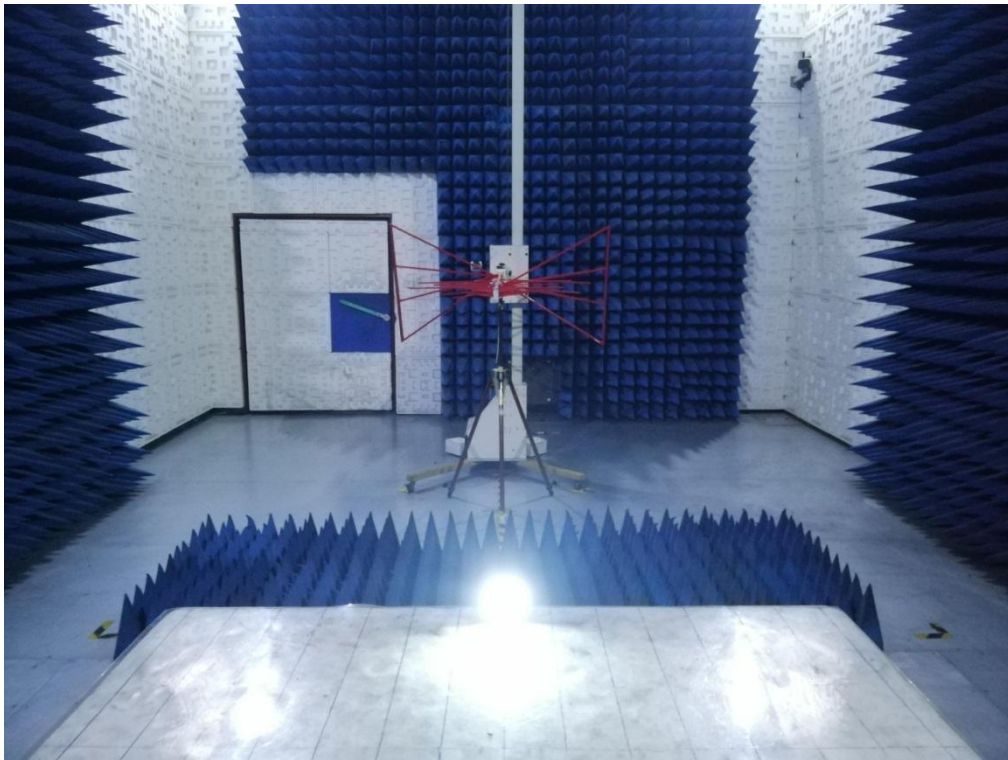

Radio-frequency electromagnetic field up to 1 GHz

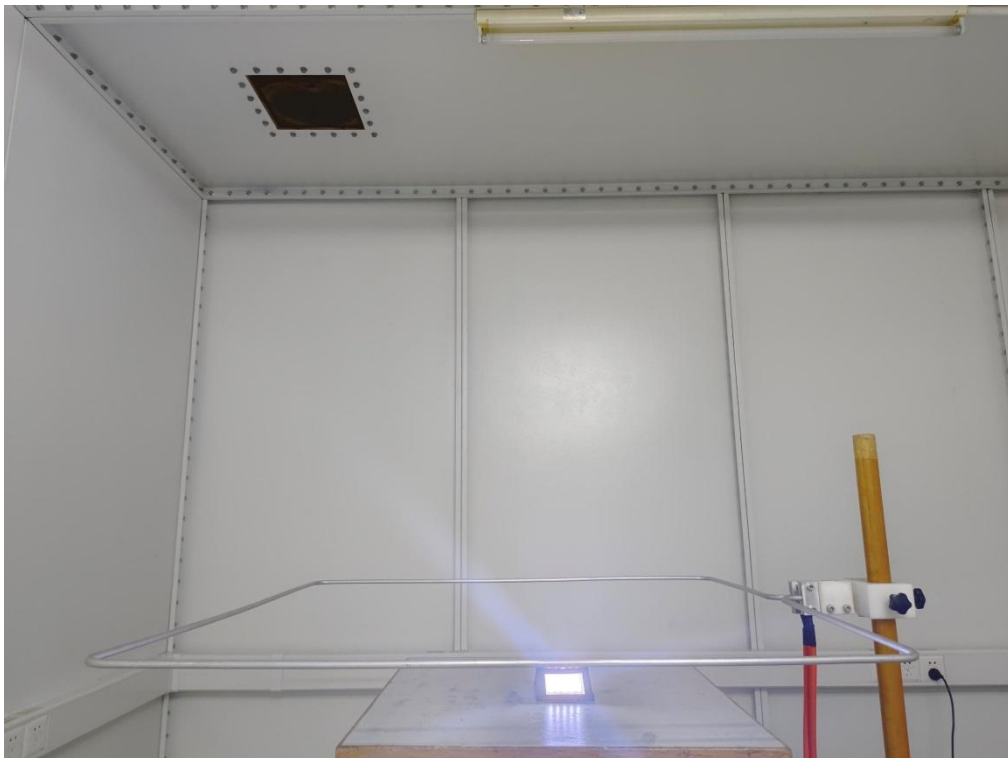

Power-frequency magnetic field

Any report having not been signed by authorized approver, or having been altered without authorization, or having not been stamped by the “Dedicated Testing/Inspection Stamp” is deemed to be invalid. Copying or excerpting portion of, or altering the content of the report is not permitted without the written authorization of AGC. The test results presented in the report apply only to the tested sample. Any objections to report issued by AGC should be submitted to AGC within 15days after the issuance of the test report. Further enquiry of validity or verification of the test report should be addressed to AGC by agc01@agccert.com.

### 10. Photographs of EUT



Top view of EUT

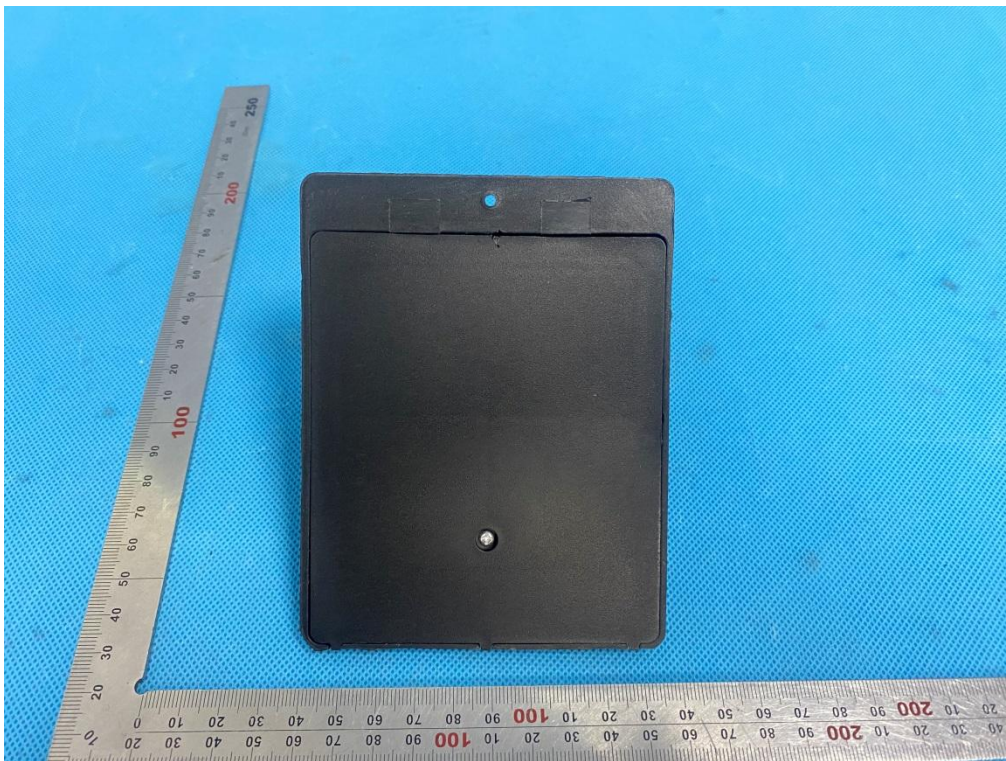

Bottom view of EUT

Any report having not been signed by authorized approver, or having been altered without authorization, or having not been stamped by the “Dedicated Testing/Inspection Stamp” is deemed to be invalid. Copying or excerpting portion of, or altering the content of the report is not permitted without the written authorization of AGC. The test results presented in the report apply only to the tested sample. Any objections to report issued by AGC should be submitted to AGC within 15days after the issuance of the test report. Further enquiry of validity or verification of the test report should be addressed to AGC by agc01@agccert.com.

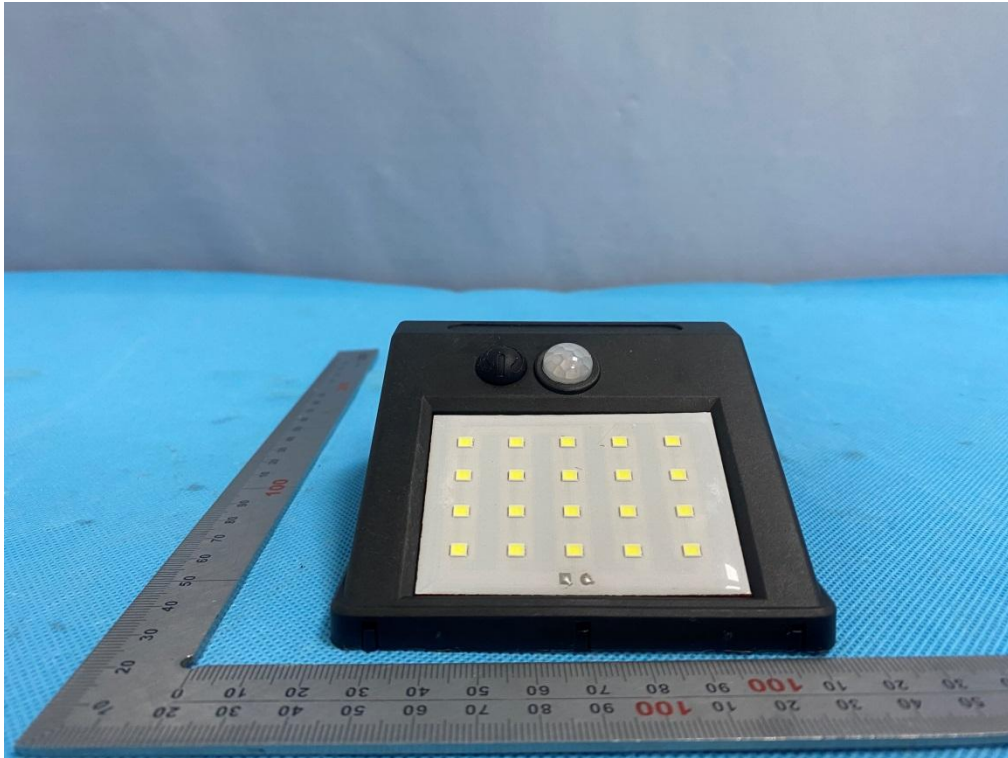

Front view of EUT

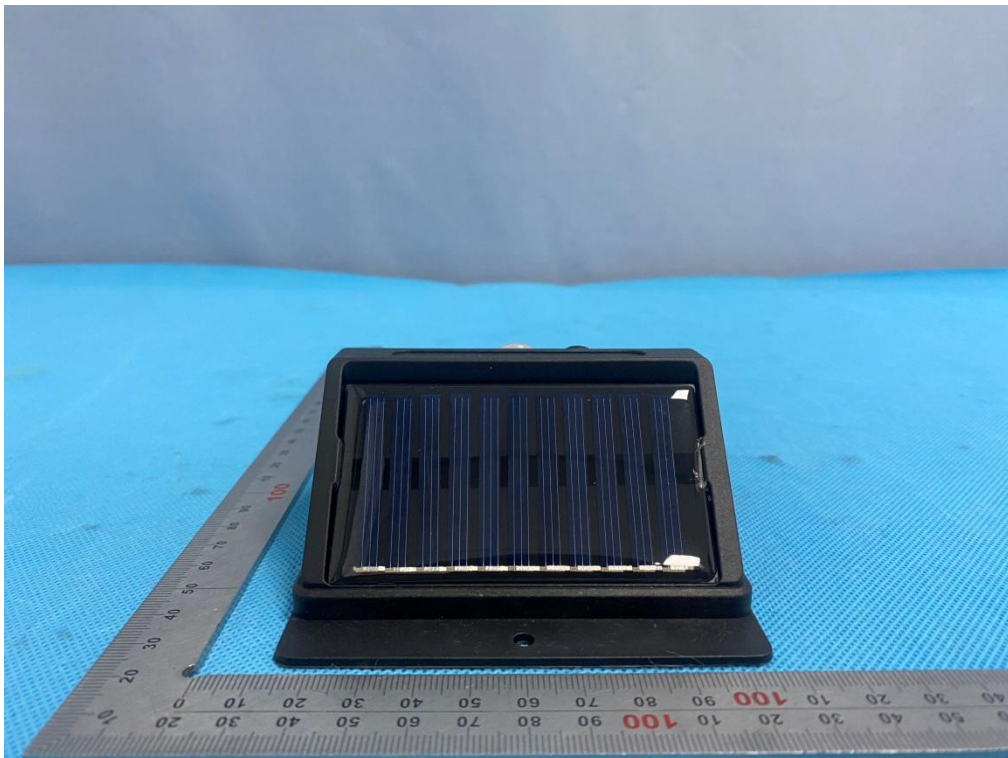

Back view of EUT

Any report having not been signed by authorized approver, or having been altered without authorization, or having not been stamped by the "Dedicated Testing/Inspection Stamp" is deemed to be invalid. Copying or excerpting portion of, or altering the content of the report is not permitted without the written authorization of AGC. The test results presented in the report apply only to the tested sample. Any objections to report issued by AGC should be submitted to AGC within 15days after the issuance of the test report. Further enquiry of validity or verification of the test report should be addressed to AGC by agc01@agccert.com.

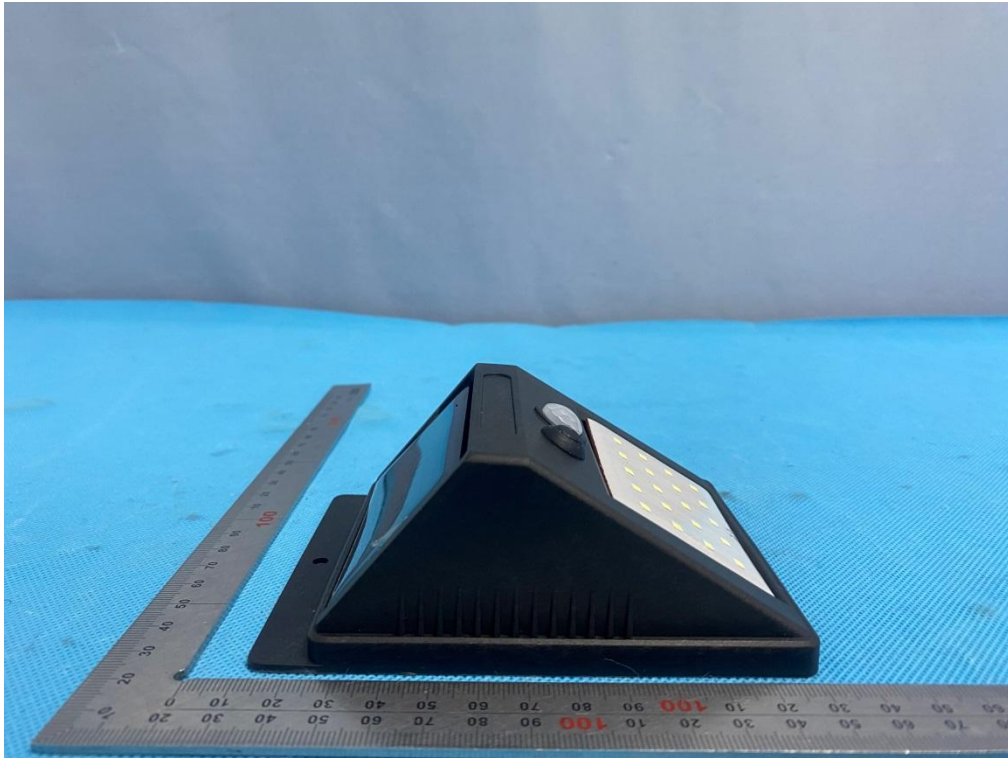

Left view of EUT

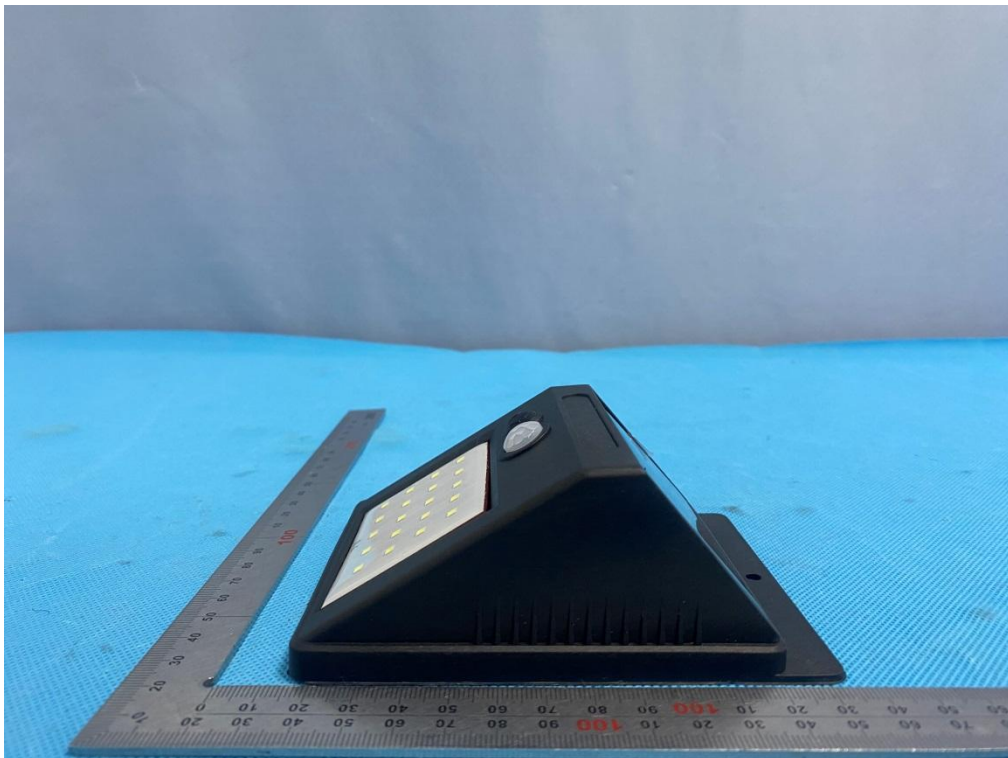

Right view of EUT

----End of Report----

Any report having not been signed by authorized approver, or having been altered without authorization, or having not been stamped by the “Dedicated Testing/Inspection Stamp” is deemed to be invalid. Copying or excerpting portion of, or altering the content of the report is not permitted without the written authorization of AGC. The test results presented in the report apply only to the tested sample. Any objections to report issued by AGC should be submitted to AGC within 15days after the issuance of the test report. Further enquiry of validity or verification of the test report should be addressed to AGC by agc01@agccert.com.



## Conditions of Issuance of Test Reports

1. All samples and goods are accepted by the Attestation of Global Compliance (Shenzhen) Co., Ltd (the “Company”) solely for testing and reporting in accordance with the following terms and conditions. The company provides its services on the basis that such terms and conditions constitute express agreement between the company and any person, firm or company requesting its services (the “Clients”).
2. Any report issued by Company as a result of this application for testing services (the “Report”) shall be issued in confidence to the Clients and the Report will be strictly treated as such by the Company. It may not be reproduced either in its entirety or in part and it may not be used for advertising or other unauthorized purposes without the written consent of the Company. The Clients to whom the Report is issued may, however, show or send it, or a certified copy thereof prepared by the Company to its customer, supplier or other persons directly concerned. The Company will not, without the consent of the Clients, enter into any discussion or correspondence with any third party concerning the contents of the Report, unless required by the relevant governmental authorities, laws or court orders.
3. The Company shall not be called or be liable to be called to give evidence or testimony on the Report in a court of law without its prior written consent, unless required by the relevant governmental authorities, laws or court orders.
4. In the event of the improper use of the report as determined by the Company, the Company reserves the right to withdraw it, and to adopt any other additional remedies which may be appropriate.
5. Samples submitted for testing are accepted on the understanding that the Report issued cannot form the basis of, or be the instrument for, any legal action against the Company.
6. The Company will not be liable for or accept responsibility for any loss or damage however arising from the use of information contained in any of its Reports or in any communication whatsoever about its said tests or investigations.
7. Clients wishing to use the Report in court proceedings or arbitration shall inform the Company to that effect prior to submitting the sample for testing.
8. The Company is not responsible for recalling the electronic version of the original report when any revision is made to them. The Client assumes the responsibility to providing the revised version to any interested party who uses them.
9. Subject to the variable length of retention time for test data and report stored hereinto as otherwise specifically required by individual accreditation authorities, the Company will only keep the supporting test data and information of the test report for a period of six years. The data and information will be disposed of after the aforementioned retention period has elapsed. Under no circumstances shall we provide any data and information which has been disposed of after retention period. Under no circumstances shall we be liable for damage of any kind, including (but not limited to) compensatory damages, lost profits, lost data, or any form of special, incidental, indirect, consequential or punitive damages of any kind, whether based on breach of contract of warranty, tort (including negligence), product liability or otherwise, even if we are informed in advance of the possibility of such damages.

Any report having not been signed by authorized approver, or having been altered without authorization, or having not been stamped by the “Dedicated Testing/Inspection Stamp” is deemed to be invalid. Copying or excerpting portion of, or altering the content of the report is not permitted without the written authorization of AGC. The test results presented in the report apply only to the tested sample. Any objections to report issued by AGC should be submitted to AGC within 15days after the issuance of the test report. Further enquiry of validity or verification of the test report should be addressed to AGC by [agc01@agccert.com](mailto:agc01@agccert.com).