



中国认可
国际互认
检测
TESTING
CNAS L4062



TEST REPORT

Reference No..... : WTF23X10222757W003
 Manufacturer : Mid Ocean Brands B.V.
 Address : 7/F., Kings Tower, 111 King Lam Street, Cheung Sha Wan, Kowloon, Hong Kong
 Factory : 114276
 Product Name : Aluminium cork base speaker
 Model No..... : MO2205
 Standards : EN 55032:2015+A1:2020; EN 55035:2017+A11:2020
 EN IEC 61000-3-2:2019+A1:2021; EN 61000-3-3:2013+A2:2021
 ETSI EN 301 489-1 V2.2.3 (2019-11)
 Draft ETSI EN 301 489-17 V3.2.5 (2022-08)
 Date of Receipt sample : 2023-10-18
 Date of Test..... : 2023-10-18 to 2023-11-13
 Date of Issue : 2023-11-13
 Test Report Form No. : WTX_ETSI EN 301 489_1_2019W
 Test Result..... : **Pass**

Remarks:

The results shown in this test report refer only to the sample(s) tested, this test report cannot be reproduced, except in full, without prior written permission of the company. The report would be invalid without specific stamp of test institute and the signatures of approver.

Prepared By:

Waltek Testing Group (Shenzhen) Co., Ltd.

Address: 1/F., Room 101, Building 1, Hongwei Industrial Park, Liuxian 2nd Road,
 Block 70 Bao'an District, Shenzhen, Guangdong, China

Tel.: +86-755-33663308 Fax.: +86-755-33663309 Email: sem@waltek.com.cn

Tested by:

Gala Wang

Approved by:

Silin Chen



TABLE OF CONTENTS

1. GENERAL INFORMATION.....	5
1.1 PRODUCT DESCRIPTION FOR EQUIPMENT UNDER TEST (EUT).....	5
1.2 TEST STANDARDS.....	6
1.3 TEST METHODOLOGY.....	6
1.4 TEST FACILITY.....	7
1.5 EUT SETUP AND OPERATION MODE.....	8
1.6 PERFORMANCE CRITERIA FOR EMS.....	9
1.7 MEASUREMENT UNCERTAINTY.....	11
1.8 TEST EQUIPMENT LIST AND DETAILS.....	12
2. SUMMARY OF TEST RESULTS.....	15
3. CONDUCTED EMISSIONS.....	16
3.1 TEST PROCEDURE.....	16
3.2 BASIC TEST SETUP BLOCK DIAGRAM.....	16
3.3 ENVIRONMENTAL CONDITIONS.....	16
3.4 CONDUCTED EMISSIONS TEST DATA.....	16
4. RADIATED EMISSIONS.....	19
4.1 TEST PROCEDURE.....	19
4.2 CORRECTED AMPLITUDE & MARGIN CALCULATION.....	19
4.3 ENVIRONMENTAL CONDITIONS.....	20
4.4 SUMMARY OF TEST RESULTS/PLOTS.....	20
5. HARMONIC CURRENT EMISSIONS.....	24
5.1 TEST SETUP BLOCK DIAGRAM.....	24
5.2 TEST STANDARDS.....	24
5.3 ENVIRONMENTAL CONDITIONS.....	24
5.4 HARMONIC CURRENT EMISSIONS TEST DATA.....	24
6. VOLTAGE FLUCTUATION AND FLICKER.....	30
6.1 TEST SETUP BLOCK DIAGRAM.....	30
6.2 TEST STANDARDS.....	30
6.3 ENVIRONMENTAL CONDITIONS.....	30
6.4 VOLTAGE FLUCTUATION AND FLICKER TEST DATA.....	30
7. ELECTROSTATIC DISCHARGE (ESD).....	32
7.1 TEST SETUP BLOCK DIAGRAM.....	32
7.2 TEST PERFORMANCE.....	32
7.3 ENVIRONMENTAL CONDITIONS.....	32
7.4 ELECTROSTATIC DISCHARGE IMMUNITY TEST DATA.....	32
8. RADIO FREQUENCY ELECTROMAGNETIC FIELD (R/S).....	34
8.1 TEST SETUP BLOCK DIAGRAM.....	34
8.2 TEST PERFORMANCE.....	34
8.3 ENVIRONMENTAL CONDITIONS.....	34
8.4 CONTINUOUS RADIATED DISTURBANCES TEST DATA.....	34
9. FAST TRANSIENTS, COMMON MODE (EFT).....	36
9.1 TEST SETUP BLOCK DIAGRAM.....	36
9.2 TEST PERFORMANCE.....	36
9.3 ENVIRONMENTAL CONDITIONS.....	36
9.4 ELECTRICAL FAST TRANSIENTS TEST DATA.....	36
10. SURGES.....	38
10.1 TEST SETUP BLOCK DIAGRAM.....	38
10.2 TEST PERFORMANCE.....	38
10.3 ENVIRONMENTAL CONDITIONS.....	38
10.4 SURGE TEST DATA.....	38



11. RADIO FREQUENCY, COMMON MODE (C/S)	40
11.1 TEST SETUP BLOCK DIAGRAM	40
11.2 TEST PERFORMANCE	40
11.3 ENVIRONMENTAL CONDITIONS	40
11.4 CONTINUOUS CONDUCTED DISTURBANCES TEST DATA	40
12. VOLTAGE DIPS AND INTERRUPTIONS	42
12.1 TEST SETUP BLOCK DIAGRAM	42
12.2 TEST PERFORMANCE	42
12.3 ENVIRONMENTAL CONDITIONS	42
12.4 VOLTAGE DIPS AND INTERRUPTIONS TEST DATA	42
EXHIBIT 1 - EUT PHOTOGRAPHS	43
EXHIBIT 2 - TEST SETUP PHOTOGRAPHS	44

WALTEK



Report version

Version No.	Date of issue	Description
Rev.00	2023-11-13	Original
/	/	/

WALTEK



1. GENERAL INFORMATION

1.1 Product Description for Equipment Under Test (EUT)

General Description of EUT	
Product Name:	Aluminium cork base speaker
Trade Name:	/
Model No.:	MO2205
Adding Model(s):	/
Rated Voltage:	DC 3.7V
Battery Capacity:	300mAh
Power Adapter:	/
Software Version:	/
Hardware Version:	/
<i>Note: The test data is gathered from a production sample, provided by the manufacturer.</i>	

Technical Characteristics of EUT	
Bluetooth	
Bluetooth Version:	Bluetooth V5.3(EDR Mode)
Frequency Range:	2402-2480MHz
Max.RF Output Power:	-5.90dBm (EIRP)
Type of Modulation:	GFSK, $\pi/4$ DQPSK, 8DPSK
Data Rate:	1Mbps, 2Mbps, 3Mbps
Quantity of Channels	79
Channel Separation:	1MHz
Type of Antenna:	PCB Antenna
Antenna Gain:	-0.58dBi
<i>Note: The Antenna Gain is provided by the customer and can affect the validity of results.</i>	



1.2 Test Standards

The tests were performed according to following standards:

EN 55032:2015+A1:2020: Electromagnetic compatibility of multimedia equipment - Emission requirements

EN 55035:2017+A11:2020: Electromagnetic compatibility of multimedia equipment - Immunity requirements.

EN IEC 61000-3-2:2019+A1:2021: Electromagnetic compatibility (EMC) -- Part 3-2: Limits - Limits for harmonic current emissions (equipment input current up to and including 16 A per phase).

EN 61000-3-3:2013+A2:2021: Electromagnetic compatibility (EMC) -- Part 3-3: Limits - Limitation of voltage changes, voltage fluctuations and flicker in public low-voltage supply systems, for equipment with rated current ≤ 16 A per phase and not subject to conditional connection.

ETSI EN 301 489-1 V2.2.3 (2019-11): Electromagnetic Compatibility (EMC) standard for radio equipment and services; Part 1: Common technical requirements; Harmonised Standard for Electromagnetic Compatibility.

Draft ETSI EN 301 489-17 V3.2.5 (2022-08): ElectroMagnetic Compatibility (EMC) standard for radio equipment and services; Part 17: Specific conditions for Broadband Data Transmission Systems; Harmonised Standard for ElectroMagnetic Compatibility.

Maintenance of compliance is the responsibility of the manufacturer. Any modification of the product maybe which result in lowering the emission/immunity should be checked to ensure compliance has been maintained.

1.3 Test Methodology

All measurements contained in this report were conducted with the standard ETSI EN 301489-1, Electromagnetic compatibility and Radio spectrum Matters (ERM); Electromagnetic Compatibility (EMC) standard for radio equipment and services; Part 1: Common technical requirements.



1.4 Test Facility

Address of the test laboratory

Laboratory: Waltek Testing Group (Shenzhen) Co., Ltd.

Address: 1/F., Room 101, Building 1, Hongwei Industrial Park, Liuxian 2nd Road, Block 70 Bao'an District, Shenzhen, Guangdong, China

FCC – Registration No.: 125990

Waltek Testing Group (Shenzhen) Co., Ltd. EMC Laboratory has been registered and fully described in a report filed with the FCC (Federal Communications Commission). The acceptance letter from the FCC is maintained in our files. The Designation Number is CN5010, and Test Firm Registration Number is 125990.

Industry Canada (IC) Registration No.: 11464A

The 3m Semi-anechoic chamber of Waltek Testing Group (Shenzhen) Co., Ltd. has been registered by Certification and Engineering Bureau of Industry Canada for radio equipment testing with Registration No.: 11464A.

WALTEK



1.5 EUT Setup and Operation Mode

The equipment under test (EUT) was configured to measure its highest possible emission/immunity level. The test modes were adapted according to the operation manual for use, more detailed description as follows:

Test Mode List		
Test Mode	Description	Remark
TM1	Charging mode	Connect to the Adapter; AC230V 50Hz for adapter
TM2	Bluetooth	TR, CR, TT, CT for EMS testing

EUT Cable List and Details			
Cable Description	Length (m)	Shielded/Unshielded	With / Without Ferrite
Type-C Cable	0.5	Unshielded	Without Ferrite

Special Cable List and Details			
Cable Description	Length (m)	Shielded/Unshielded	With / Without Ferrite
/	/	/	/

Auxiliary Equipment List and Details			
Description	Manufacturer	Model	Serial Number
Adapter	GangQi	GQ12-050200	/
Phone	XIAOMI	MI10	/



1.6 Performance Criteria for EMS

➤ EN 301 489-17, The performance criteria are:

- performance criteria A for immunity tests with phenomena of a continuous nature;
- performance criteria B for immunity tests with phenomena of a transient nature;
- performance criteria C for immunity tests with power interruptions exceeding a certain time.

The equipment shall meet the minimum performance criteria as specified in the following clauses.

Table 1: Performance criteria

Criteria	During test	After test
A	Shall operate as intended. (see note 1). Shall be no loss of function. Shall be no unintentional transmissions.	Shall operate as intended. Shall be no degradation of performance (see note 3). Shall be no loss of function. Shall be no loss of stored data or user programmable
B	May show loss of function (one or more). May show degradation of performance (see note 2). Shall be no unintentional transmissions.	Functions shall be self-recoverable. Shall operate as intended after recovering. Shall be no degradation of performance (see note 3). Shall be no loss of stored data or user programmable functions.
C	May be loss of function (one or more).	Functions shall be recoverable by the operator. Shall operate as intended after recovering. Shall be no degradation of performance (see note 3).



NOTE 1: Operate as intended during the test allows a level of degradation not below a minimum performance level specified by the manufacturer for the use of the apparatus as intended. In some cases the specified minimum performance level may be replaced by a permissible degradation of performance. If the minimum performance level or the permissible performance degradation is not specified by the manufacturer then either of these may be derived from the product description and documentation (including leaflets and advertising) and what the user may reasonably expect from the apparatus if used as intended.

NOTE 2: Degradation of performance during the test is understood as a degradation to a level not below a minimum performance level specified by the manufacturer for the use of the apparatus as intended. In some cases the specified minimum performance level may be replaced by a permissible degradation of performance. If the minimum performance level or the permissible performance degradation is not specified by the manufacturer then either of these may be derived from the product description and documentation (including leaflets and advertising) and what the user may reasonably expect from the apparatus if used as intended.

NOTE 3: No degradation of performance after the test is understood as no degradation below a minimum performance level specified by the manufacturer for the use of the apparatus as intended. In some cases the specified minimum performance level may be replaced by a permissible degradation of performance. After the test no change of actual operating data or user retrievable data is allowed. If the minimum performance level or the permissible performance degradation is not specified by the manufacturer then either of these may be derived from the product description and documentation (including leaflets and advertising) and what the user may reasonably expect from the apparatus if used as intended.

➤ **EN 55035, The performance criteria are:**

A. The apparatus shall continue to operate as intended during and after the test. The manufacturer specifies some minimum performance level. The performance level may be specified by the manufacturer as a permissible loss of performance.

B. The apparatus shall continue to operate as intended after the test. This indicates that the EUT does not need to function at normal performance levels during the test, but must recover. Again some minimal performance is defined by the manufacture. No change in operating state or loss or data is permitted.

C. Temporary loss of function is allowed. Operation of the EUT may stop as long as it is either automatically reset or can be manually restored by operation of the controls.



1.7 Measurement Uncertainty

Measurement uncertainty	
Parameter	Uncertainty
Uncertainty for Radiated Emission in 3m chamber	@30-200MHz ± 4.52 dB @0.2-1GHz ± 5.56 dB @1-6GHz ± 3.84 dB @6-18GHz ± 3.92 dB
Uncertainty for Conducted Emission	@9-150kHz ± 3.74 dB @0.15-30MHz ± 3.34 dB
Uncertainty for Harmonic test	3.26%
Uncertainty for Flicker test	4.76%
Uncertainty for RS test	21%, k=2
Uncertainty for CS test	29%, k=2
Uncertainty for ESD test	The immunity measurement system uncertainty is within standard requirement and is based on a standard uncertainty multiplied by a coverage factor k=2, providing a level of confidence of approximately 95%.
Uncertainty for EFT test	
Uncertainty for Surges test	
Uncertainty for Voltage Dips, Voltage Variations and Short Interruptions Test	
Uncertainty for PFMF test	



1.8 Test Equipment List and Details

Description	Manufacturer	Model	Serial Number	Cal Date	Due Date
<input type="checkbox"/> Chamber A: Below 1GHz					
Spectrum Analyzer	Rohde & Schwarz	FSP30	836079/035	2023-02-25	2024-02-24
EMI Test Receiver	Rohde & Schwarz	ESVB	825471/005	2023-02-25	2024-02-24
Amplifier	HP	8447F	2805A03475	2023-02-25	2024-02-24
Loop Antenna	Schwarz beck	FMZB 1516	9773	2021-03-20	2024-03-19
Trilog Broadband Antenna	Schwarz beck	VULB9163	9163-333	2023-03-20	2026-03-19
<input type="checkbox"/> Chamber A: Above 1GHz					
Spectrum Analyzer	Rohde & Schwarz	FSP30	836079/035	2023-02-25	2024-02-24
Spectrum Analyzer	Rohde & Schwarz	FSP40	100612	2023-02-25	2024-02-24
EMI Test Receiver	Rohde & Schwarz	ESVB	825471/005	2023-02-25	2024-02-24
Amplifier	C&D	PAP-1G18	14918	2023-02-25	2024-02-24
Horn Antenna	ETS	3117	00086197	2021-03-19	2024-03-18
DRG Horn Antenna	A.H. SYSTEMS	SAS-574	571	2021-03-19	2024-03-18
Pre-amplifier	Schwarzbeck	BBV 9721	9721-031	2023-02-25	2024-02-24
<input type="checkbox"/> Chamber B: Below 1GHz					
Trilog Broadband Antenna	Schwarz beck	VULB9163(B)	9163-635	2021-04-09	2024-04-08
Amplifier	Agilent	8447D	2944A10457	2023-02-25	2024-02-24
EMI Test Receiver	Rohde & Schwarz	ESPI	101391	2023-02-25	2024-02-24
<input checked="" type="checkbox"/> Chamber C: Below 1GHz					
EMI Test Receiver	Rohde & Schwarz	ESIB 26	100401	2023-02-25	2024-02-24
Trilog Broadband Antenna	Schwarz beck	VULB 9168	1194	2021-05-28	2024-05-27
Loop Antenna	Schwarz beck	FMZB 1516	9773	2021-03-20	2024-03-19
Amplifier	HP	8447F	2944A03869	2023-02-25	2024-02-24
<input checked="" type="checkbox"/> Chamber C: Above 1GHz					
EMI Test Receiver	Rohde & Schwarz	ESIB 26	100401	2023-02-25	2024-02-24
Horn Antenna	POAM	RTF-118A	1820	2023-03-10	2026-03-09
Amplifier	Tonscend	TAP01018050	AP22E806235	2023-02-25	2024-02-24
DRG Horn Antenna	A.H. SYSTEMS	SAS-574	571	2021-03-19	2024-03-18
Pre-amplifier	Schwarzbeck	BBV 9721	9721-031	2023-02-25	2024-02-24
<input type="checkbox"/> Conducted Room 1#					
EMI Test Receiver	Rohde & Schwarz	ESPI	101611	2023-02-25	2024-02-24
Pulse Limiter	Rohde & Schwarz	ESH3-Z2	100911	2023-02-25	2024-02-24
AC LISN	Schwarz beck	NSLK8126	8126-279	2023-02-25	2024-02-24
8-WIRE LISN	Schwarz beck	8158	CAT3-8158-0059	2023-02-25	2024-02-24
8-WIRE LISN	Schwarz beck	8158	CAT5-8158-0117	2023-02-25	2024-02-24



<input checked="" type="checkbox"/> Conducted Room 2#					
EMI Test Receiver	Rohde & Schwarz	ESPI	101259	2023-02-25	2024-02-24
LISN	Rohde & Schwarz	ENV 216	100097	2023-02-25	2024-02-24
EMF					
VDH Test Head	AFJ	VDH 30	SC022Z	2023-02-25	2024-02-24
3 Loop Antenna					
Loop Antenna	ZHINAN	ZN30401	19037	2023-02-25	2025-02-24
Clamp					
Clamp	Luthi	MDS21	3809	2023-02-27	2024-02-26
PFMF					
PMF Generator	LIONCEL	PMF-801C-C	0171101	2023-02-25	2024-02-24
PMF Antenna	LIONCEL	PMF-801C-A	0180302	2023-02-25	2024-02-24
Instantaneous PMF Generator Module	LIONCEL	PMF-801C-T	0171001	2023-02-25	2024-02-24
H/F					
Digital Power Analyzer	California Instrument	CTS	72831	2023-02-25	2024-02-24
Power Source	California Instrument	5001IX-CTS-400	60077	2023-02-25	2024-02-24
ESD					
ESD Generator	LIONCEL	ESD-203B	0170901	2023-03-14	2024-03-13
EFT/SURGE/DIPS					
Transient 2000	EMC PARTNER	TRA2000	836	2023-02-25	2024-02-24
Couple Clamp	EMC PARTNER	CN-EFT1000	513	2023-02-25	2024-02-24
CS					
CONDUCTED IMMUNITY TEST SYSTEM	FRANKONIA	CIT-10/75	126B1247/2013	2023-02-25	2024-02-24
Attenuator	EMTEST	MA-5100/6BF2	1009	2023-02-25	2024-02-24
CDN	Luthi	L-801M2/M3	2665	2023-02-25	2024-02-24
CDN	LIONCEL	CDN-T8	0210401	2023-02-25	2024-02-24
EM Clamp	TESEQ	KEMZ801A	45028	2023-02-25	2024-02-24
RS					
Signal Generator	HP	8665B	3438A00604	2023-02-25	2024-02-24
Power Sensor	Agilent	E9301A	MY52450001	2023-02-25	2024-02-24
Power Sensor	Agilent	E9304A	MY55081055	2023-02-25	2024-02-24
RF Power Amplifier	MicoTop	MPA-80-1000-250	MPA1906239	2023-02-25	2024-02-24
RF Power Amplifier	MicoTop	MPA-80-6000-100	MPA1906238	2023-02-25	2024-02-24
Antenna	SCHWARZBECK	STLP 9129	9129 114	N/A	N/A



Power Meter	Agilent	E4419B	GB42420578	2023-02-25	2024-02-24
-------------	---------	--------	------------	------------	------------

Software List			
Description	Manufacturer	Model	Version
EMI Test Software (Radiated Emission)*	Farad	EZ-EMC	RA-03A1
EMI Test Software (Conducted Emission Room 1#)*	Farad	EZ-EMC	RA-03A1
EMI Test Software (Conducted Emission Room 2#)*	SKET	EMC-I	V2.0

*Remark: indicates software version used in the compliance certification testing.





2. SUMMARY OF TEST RESULTS

Standards	Reference	Description of Test Item	Result
ETSI EN 301 489-1	8.2	Radiated Emissions	Pass
	8.3	Conducted Emissions for DC Power Port	N/A
	8.4	Conducted Emissions for AC Power Port	Pass
	8.5	Harmonic Current Emissions	Pass
	8.6	Voltage Fluctuations and Flicker	Pass
	8.7	Telecommunication Ports	N/A
	9.2	Radio Frequency Electromagnetic Field	Pass
	9.3	Electrostatic Discharge	Pass
	9.4	Fast Transients, Common Mode	Pass
	9.5	Radio Frequency, Common Mode	Pass
	9.6	Transient and Surges in the Vehicular Environment	N/A
	9.7	Voltage Dips and Interruptions	Pass
	9.8	Surges	Pass

Pass: The EUT complies with the essential requirements in the standard.

Fail: The EUT does not comply with the essential requirements in the standard.

N/A: Not applicable.

3. Conducted Emissions

3.1 Test Procedure

Test is conducting under the description of EN55032 Information technology equipment - Radio disturbance characteristics - Limits and methods of measurement.

3.2 Basic Test Setup Block Diagram

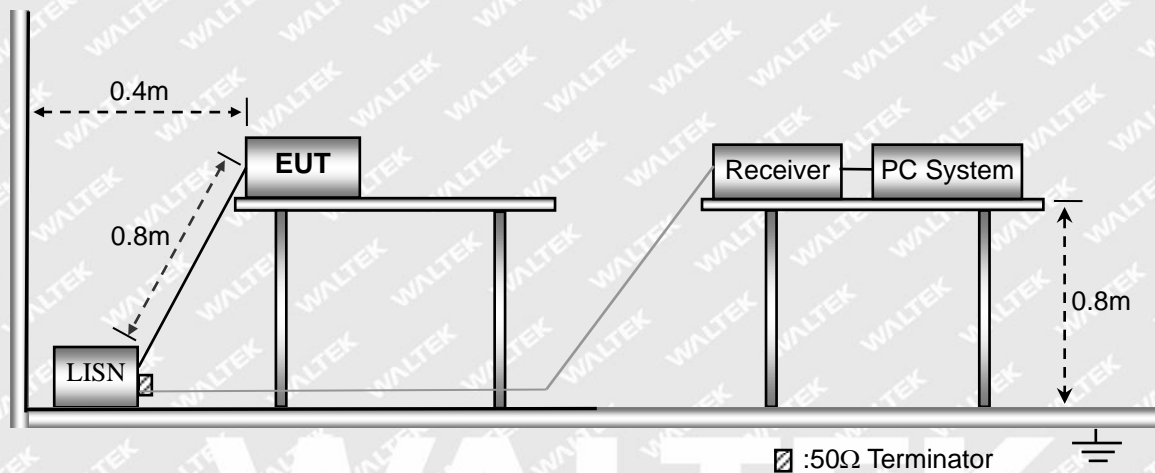

3.3 Environmental Conditions

Temperature:	25 °C
Relative Humidity:	45 %
ATM Pressure:	1015 mbar

3.4 Conducted Emissions Test Data

Note: Only show the worst case in the test report



Test mode:	TM1	Polarity:	Neutral
------------	-----	-----------	---------

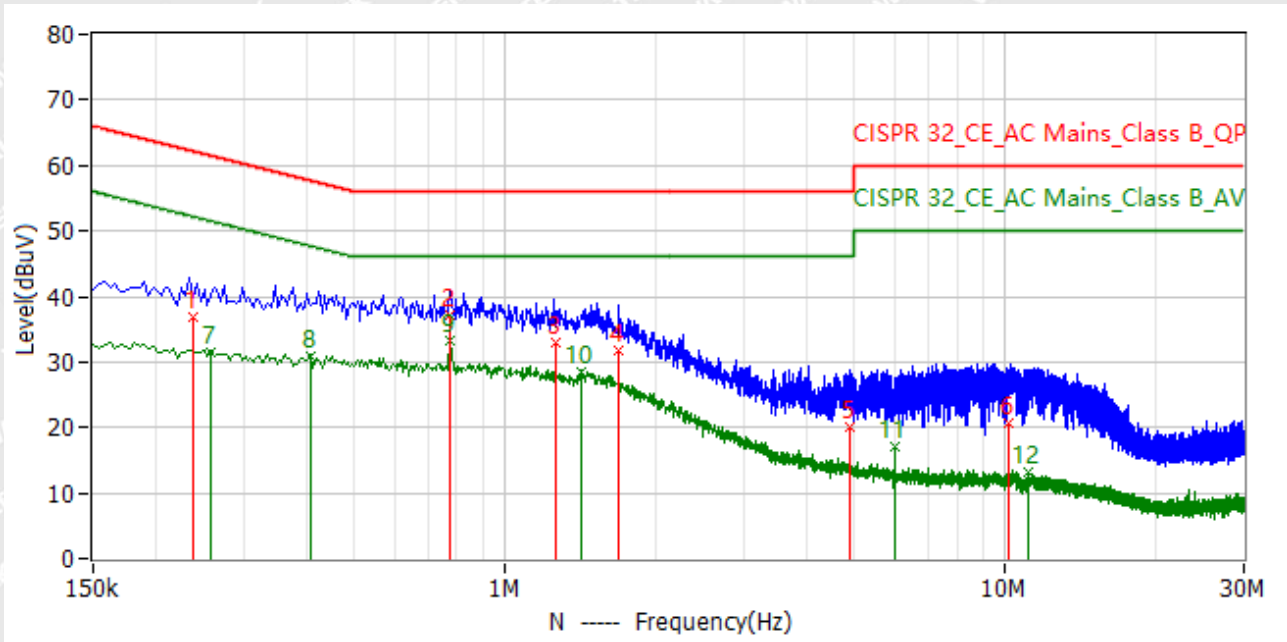

No.	Frequency	Limit dBuV	Level dBuV	Delta dB	Reading dBuV	Factor dB	Detector
1	238.000kHz	62.2	36.9	-25.3	16.5	20.4	QP
2	778.000kHz	56.0	37.2	-18.8	16.4	20.8	QP
3	1.266MHz	56.0	33.1	-22.9	12.3	20.8	QP
4	1.682MHz	56.0	31.8	-24.2	11.0	20.8	QP
5	4.878MHz	56.0	20.2	-35.8	-0.7	20.9	QP
6	10.142MHz	60.0	20.6	-39.4	-0.2	20.8	QP
7*	258.000kHz	51.5	31.6	-19.9	11.3	20.3	AV
8*	410.000kHz	47.6	31.0	-16.6	10.1	20.9	AV
9*	778.000kHz	46.0	33.2	-12.8	12.4	20.8	AV
10*	1.422MHz	46.0	28.6	-17.4	7.8	20.8	AV
11*	6.030MHz	50.0	17.0	-33.0	-3.8	20.8	AV
12*	11.114MHz	50.0	13.1	-36.9	-7.7	20.8	AV



Test mode:	TM1	Polarity:	Line
------------	-----	-----------	------

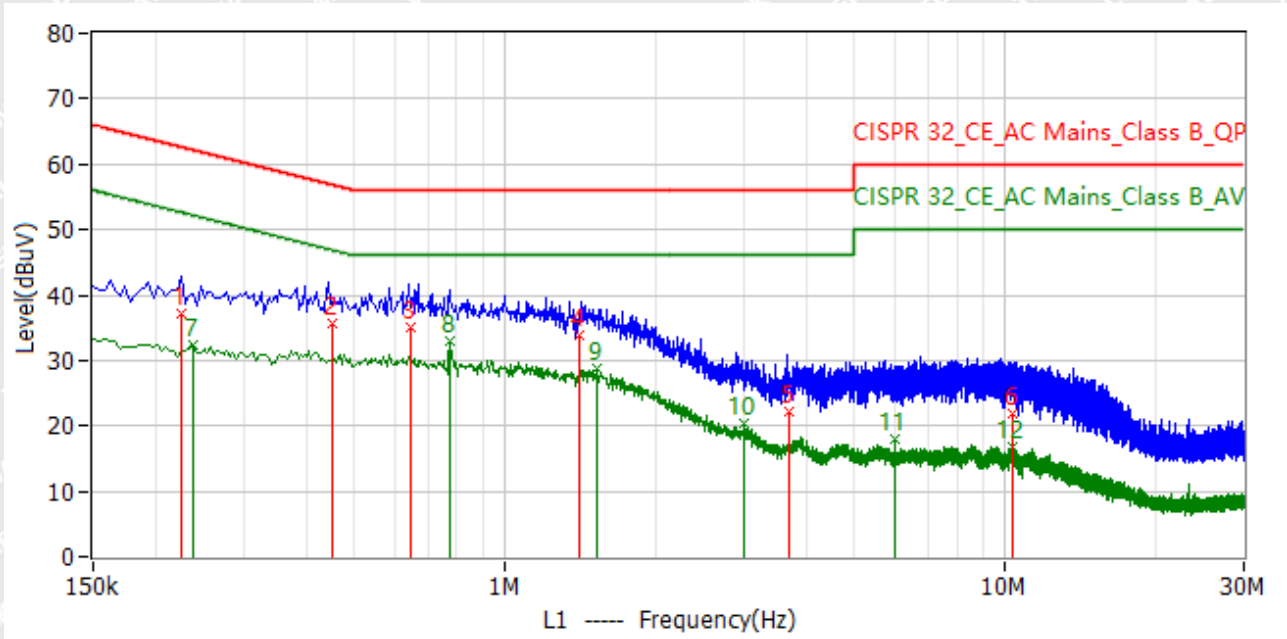

No.	Frequency	Limit dBuV	Level dBuV	Delta dB	Reading dBuV	Factor dB	Detector
1	226.000kHz	62.6	37.2	-25.4	16.7	20.5	QP
2	450.000kHz	56.9	35.6	-21.3	14.8	20.8	QP
3	646.000kHz	56.0	35.2	-20.8	14.5	20.7	QP
4	1.402MHz	56.0	33.8	-22.2	13.0	20.8	QP
5	3.706MHz	56.0	22.1	-33.9	1.2	20.9	QP
6	10.302MHz	60.0	22.0	-38.0	1.2	20.8	QP
7*	238.000kHz	52.2	32.3	-19.8	11.9	20.4	AV
8*	774.000kHz	46.0	33.0	-13.0	12.2	20.8	AV
9*	1.522MHz	46.0	28.8	-17.2	8.0	20.8	AV
10*	3.014MHz	46.0	20.3	-25.7	-0.6	20.9	AV
11*	6.030MHz	50.0	18.1	-31.9	-2.7	20.8	AV
12*	10.314MHz	50.0	16.9	-33.1	-3.9	20.8	AV



4. Radiated Emissions

4.1 Test Procedure

Test is conducting under the description of EN55032 Information technology equipment - Radio disturbance characteristics - Limits and methods of measurement.

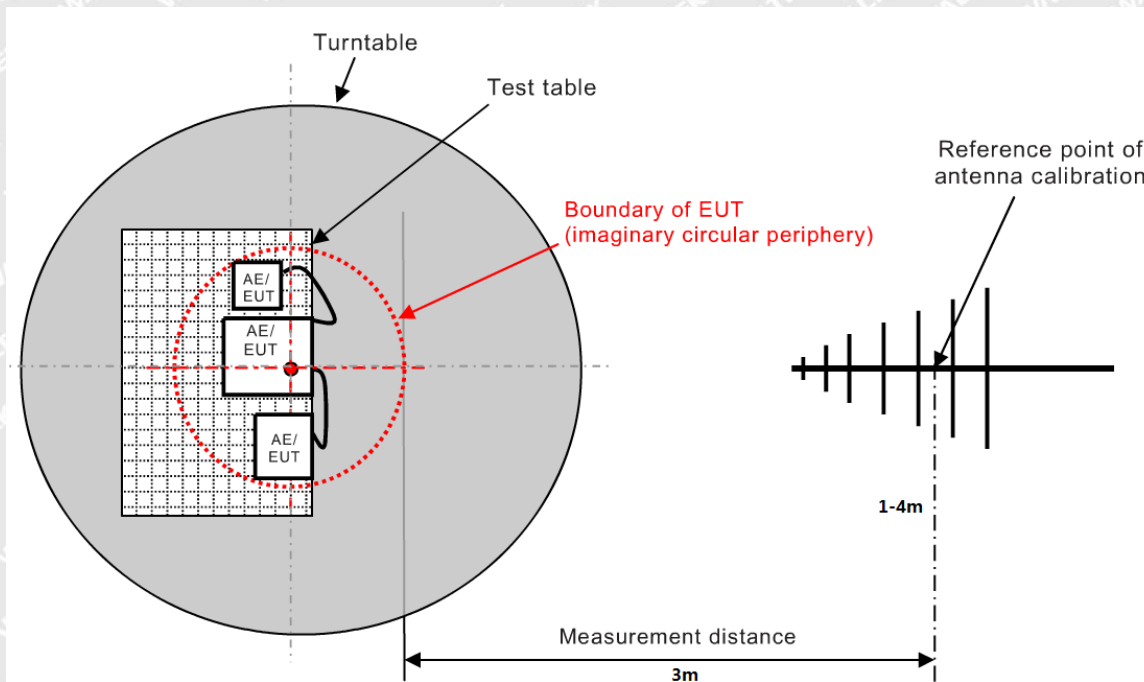

4.2 Corrected Amplitude & Margin Calculation

The Corrected Amplitude is calculated by adding the Antenna Factor and the Cable Factor, and subtracting the Amplifier Gain from the Amplitude reading. The basic equation is as follows:

$$\text{Corr. Ampl.} = \text{Indicated Reading} + \text{Antenna Factor} + \text{Cable Factor} - \text{Amplifier Gain}$$

The "**Margin**" column of the following data tables indicates the degree of compliance with the applicable limit. For example, a margin of $-6\text{dB}\mu\text{V}$ means the emission is $6\text{dB}\mu\text{V}$ below the maximum limit for Class B device. The equation for margin calculation is as follows:

$$\text{Margin} = \text{Corr. Ampl.} - \text{EN 301489 Class B Limit}$$



4.3 Environmental Conditions

Temperature:	23.5° C
Relative Humidity:	54%
ATM Pressure:	1011 mbar

4.4 Summary of Test Results/Plots

Note: Only show the worst case in the test report

➤ 30MHz to 1GHz

Test mode:	TM1	Polarity:	Horizontal
------------	-----	-----------	------------

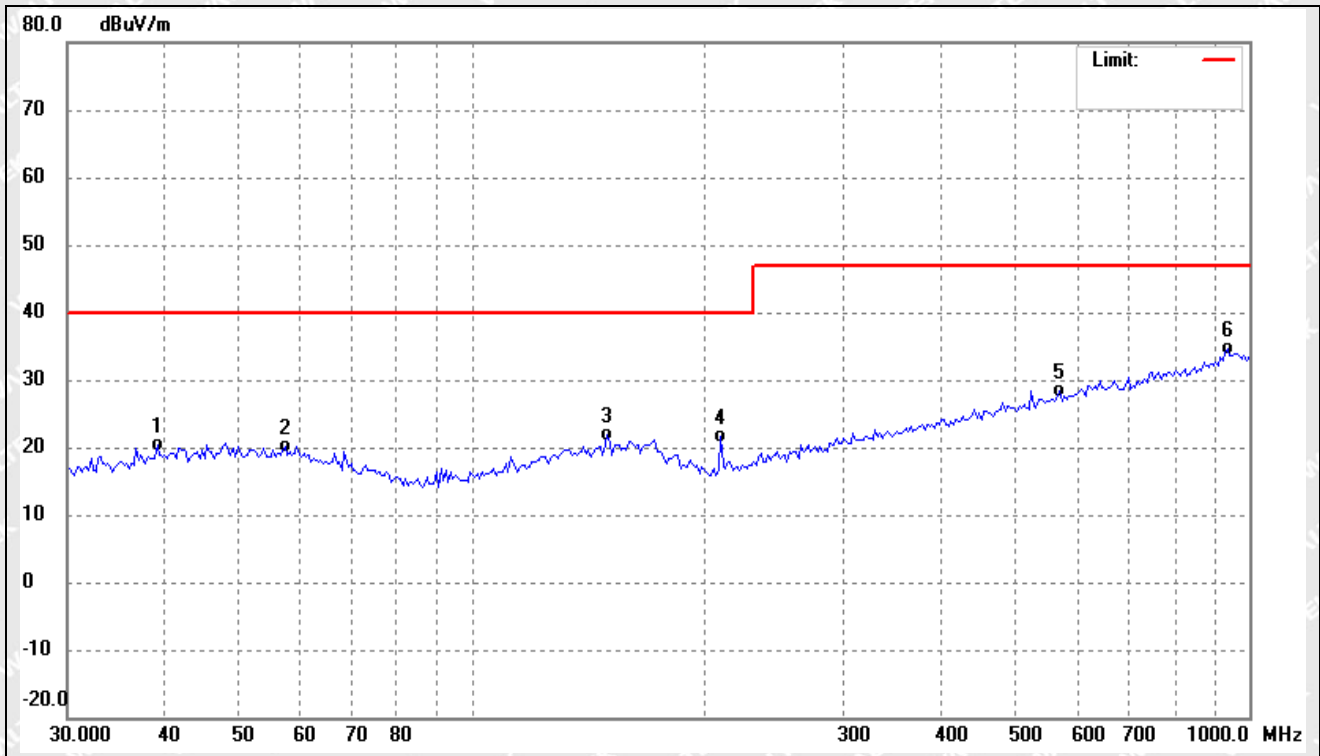

No.	Frequency (MHz)	Reading (dBuV/m)	Correct (dB/m)	Result (dBuV/m)	Limit (dBuV/m)	Margin (dB)	Degree ()	Height (cm)	Remark
1	39.1825	29.14	-8.65	20.49	40.00	-19.51	-	-	QP
2	57.2654	28.95	-8.77	20.18	40.00	-19.82	-	-	QP
3	148.9175	30.54	-8.68	21.86	40.00	-18.14	-	-	QP
4	208.6580	33.78	-12.17	21.61	40.00	-18.39	-	-	QP
5	569.9688	30.82	-2.36	28.46	47.00	-18.54	-	-	QP
6	938.7139	32.61	2.01	34.62	47.00	-12.38	-	-	QP



Test mode:	TM1	Polarity:	Vertical
------------	-----	-----------	----------

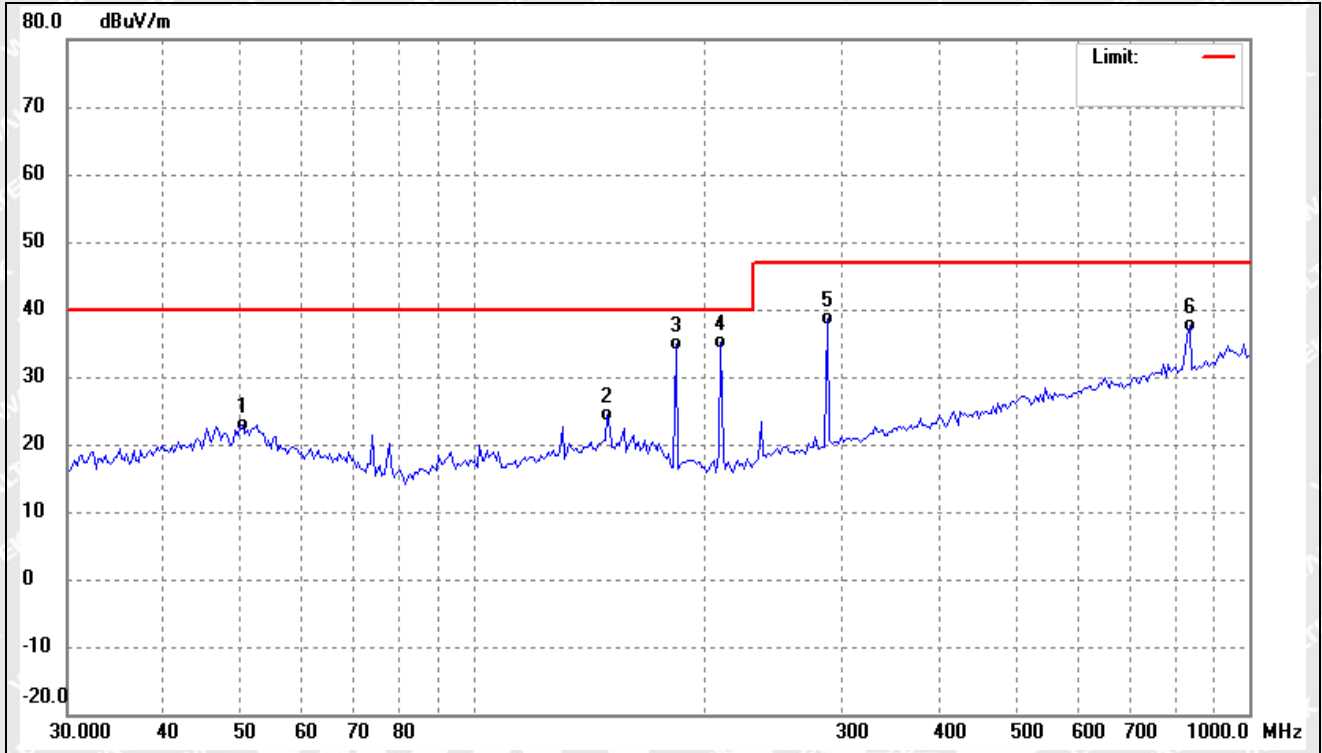

No.	Frequency (MHz)	Reading (dBuV/m)	Correct (dB/m)	Result (dBuV/m)	Limit (dBuV/m)	Margin (dB)	Degree ()	Height (cm)	Remark
1	50.4614	31.03	-8.14	22.89	40.00	-17.11	-	-	QP
2	148.9175	32.98	-8.68	24.30	40.00	-15.70	-	-	QP
3	182.5785	45.57	-10.60	34.97	40.00	-5.03	-	-	QP
4	208.6580	47.23	-12.17	35.06	40.00	-4.94	-	-	QP
5	286.2653	47.41	-8.72	38.69	47.00	-8.31	-	-	QP
6	838.8870	36.88	0.64	37.52	47.00	-9.48	-	-	QP



➤ Above 1GHz

Test mode:	TM1	Polarity:	Horizontal
------------	-----	-----------	------------

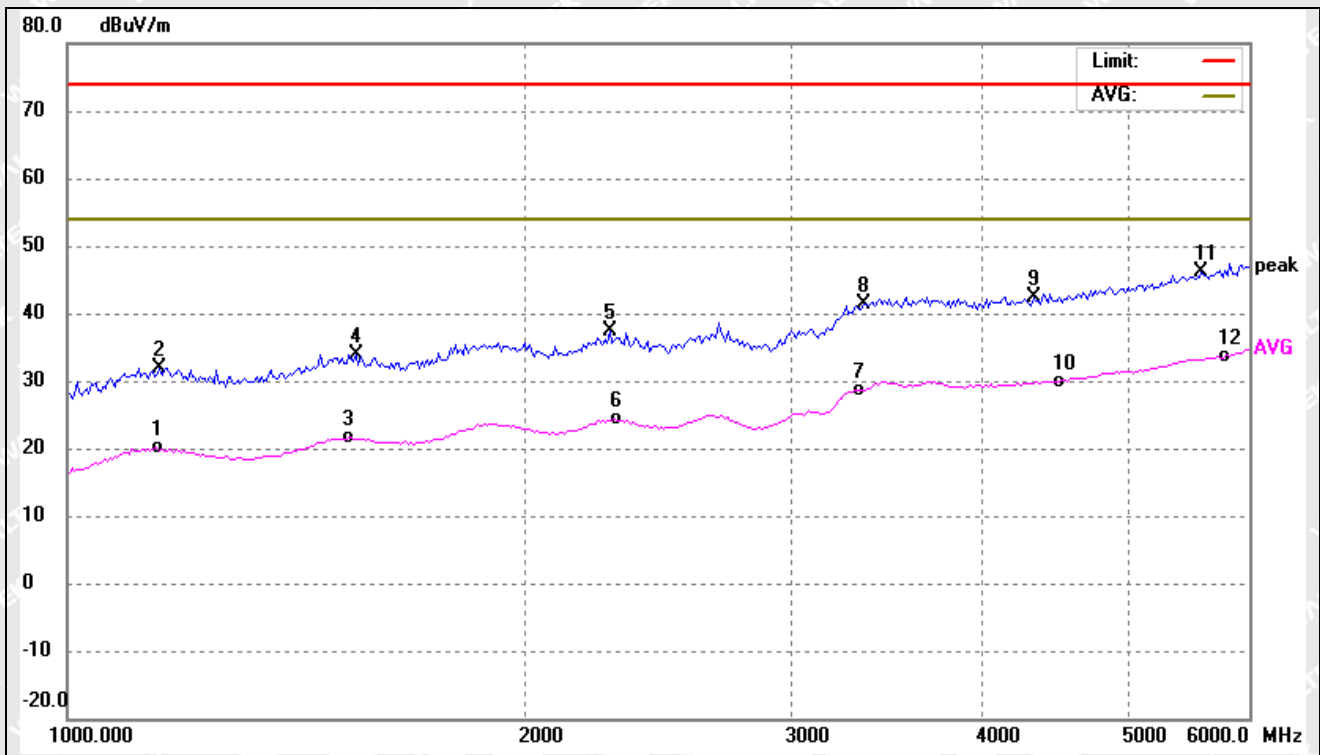

No.	Frequency (MHz)	Reading (dBuV/m)	Correct (dB/m)	Result (dBuV/m)	Limit (dBuV/m)	Margin (dB)	Degree ()	Height (cm)	Remark
1	1142.085	44.26	-24.20	20.06	54.00	-33.94	-	-	AVG
2	1150.317	55.93	-24.13	31.80	74.00	-42.20	-	-	peak
3	1533.102	44.07	-22.40	21.67	54.00	-32.33	-	-	AVG
4	1549.706	56.16	-22.30	33.86	74.00	-40.14	-	-	peak
5	2275.661	56.52	-19.09	37.43	74.00	-36.57	-	-	peak
6	2292.062	43.34	-19.06	24.28	54.00	-29.72	-	-	AVG
7	3305.882	44.07	-15.54	28.53	54.00	-25.47	-	-	AVG
8	3341.685	56.75	-15.28	41.47	74.00	-32.53	-	-	peak
9	4327.568	56.05	-13.68	42.37	74.00	-31.63	-	-	peak
10	4453.683	43.19	-13.26	29.93	54.00	-24.07	-	-	AVG
11	5584.224	55.97	-9.74	46.23	74.00	-27.77	-	-	peak
12	5726.362	42.93	-9.40	33.53	54.00	-20.47	-	-	AVG



Test mode:	TM1	Polarity:	Vertical
------------	-----	-----------	----------

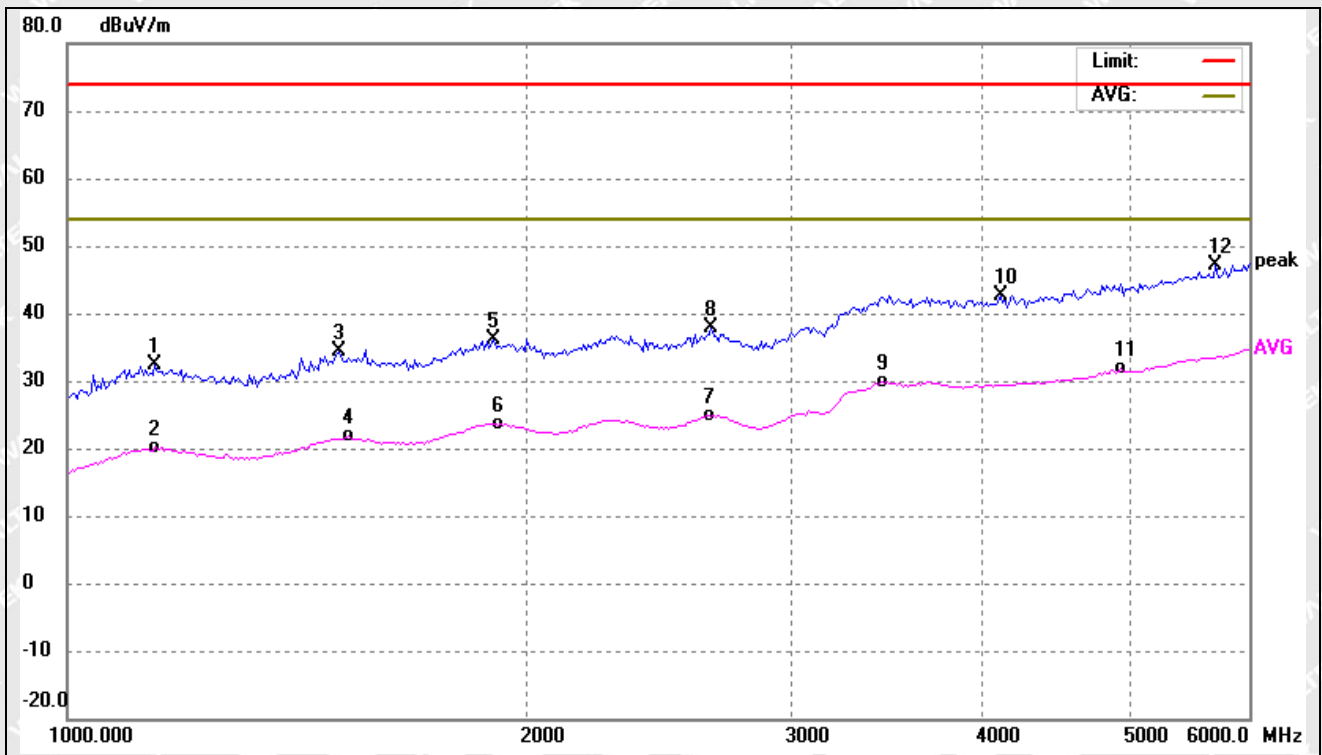

No.	Frequency (MHz)	Reading (dBuV/m)	Correct (dB/m)	Result (dBuV/m)	Limit (dBuV/m)	Margin (dB)	Degree ()	Height (cm)	Remark
1	1142.085	56.65	-24.20	32.45	74.00	-41.55	-	-	peak
2	1142.085	44.35	-24.20	20.15	54.00	-33.85	-	-	AVG
3	1511.240	56.97	-22.55	34.42	74.00	-39.58	-	-	peak
4	1533.102	44.18	-22.40	21.78	54.00	-32.22	-	-	AVG
5	1908.516	56.31	-20.17	36.14	74.00	-37.86	-	-	peak
6	1915.381	43.80	-20.13	23.67	54.00	-30.33	-	-	AVG
7	2636.597	43.20	-18.37	24.83	54.00	-29.17	-	-	AVG
8	2655.600	56.22	-18.34	37.88	74.00	-36.12	-	-	peak
9	3439.069	44.43	-14.62	29.81	54.00	-24.19	-	-	AVG
10	4115.400	56.98	-14.40	42.58	74.00	-31.42	-	-	peak
11	4942.452	44.33	-12.48	31.85	54.00	-22.15	-	-	AVG
12	5705.837	56.47	-9.44	47.03	74.00	-26.97	-	-	peak

Remark: '- Means' the test Degree and Height are not recorded by the test software and only show the worst case in the test report.



5. Harmonic Current Emissions

5.1 Test Setup Block Diagram

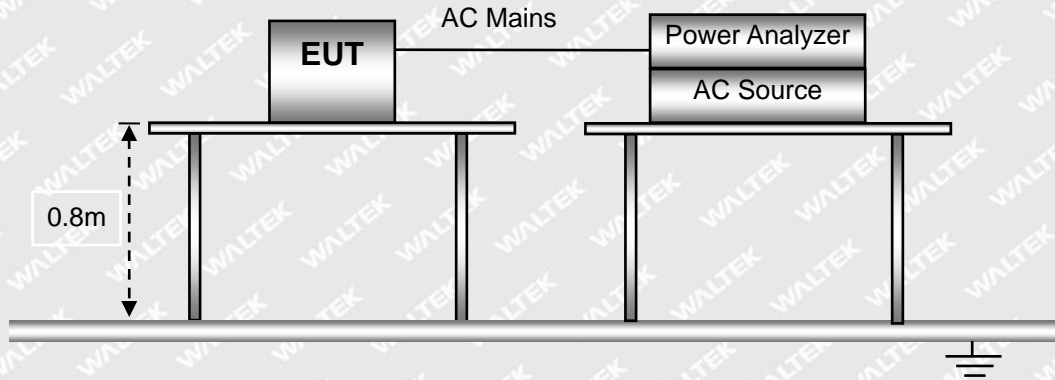

5.2 Test Standards

EN IEC 61000-3-2, Clause 7.2 Limits for Class A equipment.

5.3 Environmental Conditions

Temperature:	26 °C
Relative Humidity:	55%
ATM Pressure:	1015 mbar

5.4 Harmonic Current Emissions Test Data



Harmonics – Class-A

Test category: Class-A (European limits) **Test Margin: 100**
Test date: 2023/10/23 **Start time: 17:15:30** **End time: 17:18:11**
Test duration (min): 2.5 **Data file name: H-000739.cts_data**
Test Result: Pass **Source qualification: Normal**
Current & voltage waveforms

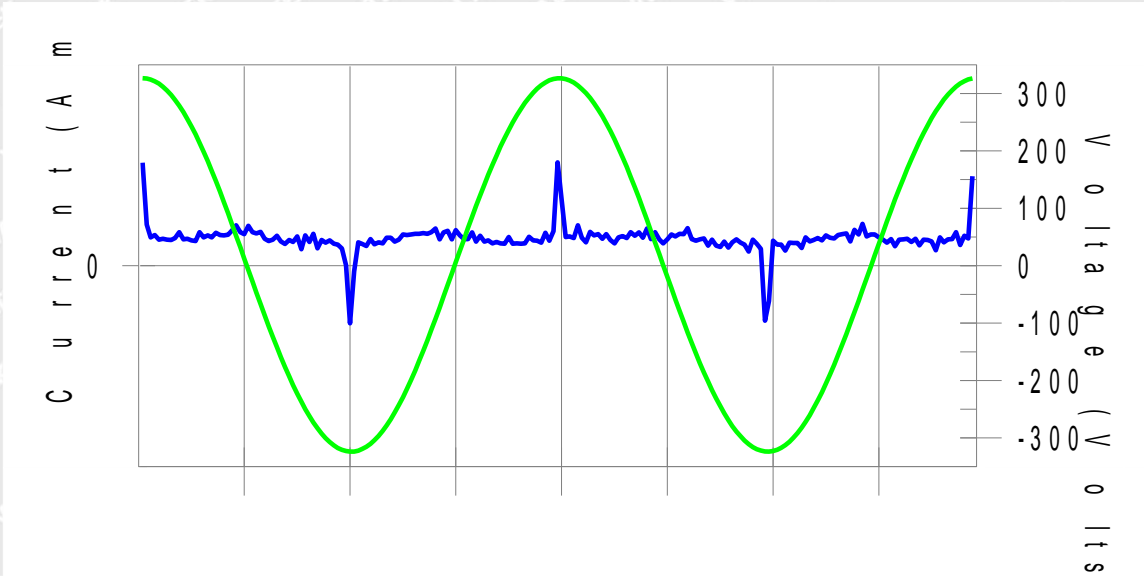

Harmonics and Class A limit line European Limits

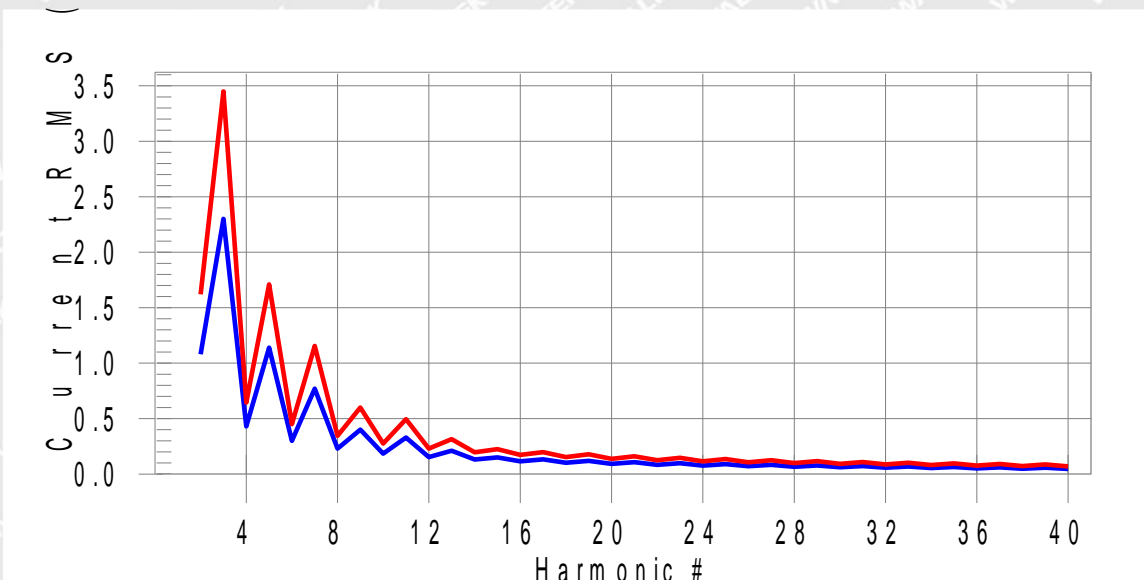

Test result: Pass Worst harmonics H0-0.0% of 150% limit, H0-0% of 100% limit



Current Test Result Summary (Run time)

Test category: Class-A (European limits) Test Margin: 100
 Test date: 2023/10/23 Start time: 17:15:30 End time: 17:18:11
 Test duration (min): 2.5 Data file name: H-000739.cts_data

Test Result: Pass Source qualification: Normal
 THC(A): 0.012 I-THD(%): 223.8 POHC(A): 0.006 POHC Limit(A): 0.251

Highest parameter values during test:

V_RMS (Volts): 230.07 Frequency(Hz): 50.00
 I_Peak (Amps): 0.122 I_RMS (Amps): 0.030
 I_Fund (Amps): 0.005 Crest Factor: 4.090
 Power (Watts): 1.2 Power Factor: 0.182

Harm#	Harms(avg)	100%Limit	%of Limit	Harms(max)	150%Limit	%of Limit	Status
2	0.001	1.080	N/A	0.001	1.620	N/A	Pass
3	0.004	2.300	N/A	0.004	3.450	N/A	Pass
4	0.001	0.430	N/A	0.001	0.645	N/A	Pass
5	0.003	1.140	N/A	0.004	1.710	N/A	Pass
6	0.000	0.300	N/A	0.000	0.450	N/A	Pass
7	0.003	0.770	N/A	0.004	1.155	N/A	Pass
8	0.000	0.230	N/A	0.000	0.345	N/A	Pass
9	0.003	0.400	N/A	0.004	0.600	N/A	Pass
10	0.000	0.184	N/A	0.000	0.276	N/A	Pass
11	0.003	0.330	N/A	0.003	0.495	N/A	Pass
12	0.000	0.153	N/A	0.000	0.230	N/A	Pass
13	0.003	0.210	N/A	0.003	0.315	N/A	Pass
14	0.000	0.131	N/A	0.000	0.197	N/A	Pass
15	0.003	0.150	N/A	0.003	0.225	N/A	Pass
16	0.000	0.115	N/A	0.000	0.173	N/A	Pass
17	0.003	0.132	N/A	0.003	0.198	N/A	Pass
18	0.000	0.102	N/A	0.000	0.153	N/A	Pass
19	0.003	0.118	N/A	0.003	0.178	N/A	Pass
20	0.000	0.092	N/A	0.000	0.138	N/A	Pass
21	0.003	0.107	N/A	0.003	0.161	N/A	Pass
22	0.000	0.084	N/A	0.000	0.125	N/A	Pass
23	0.002	0.098	N/A	0.003	0.147	N/A	Pass
24	0.000	0.077	N/A	0.000	0.115	N/A	Pass
25	0.002	0.090	N/A	0.002	0.135	N/A	Pass
26	0.000	0.071	N/A	0.000	0.107	N/A	Pass
27	0.002	0.083	N/A	0.002	0.125	N/A	Pass



Reference No.: WTF23X10222757W003

28	0.000	0.066	N/A	0.000	0.099	N/A	Pass
29	0.002	0.078	N/A	0.002	0.116	N/A	Pass
30	0.000	0.061	N/A	0.000	0.092	N/A	Pass
31	0.002	0.073	N/A	0.002	0.109	N/A	Pass
32	0.000	0.058	N/A	0.000	0.086	N/A	Pass
33	0.002	0.068	N/A	0.002	0.102	N/A	Pass
34	0.000	0.054	N/A	0.000	0.081	N/A	Pass
35	0.001	0.064	N/A	0.002	0.096	N/A	Pass
36	0.000	0.051	N/A	0.000	0.077	N/A	Pass
37	0.001	0.061	N/A	0.001	0.091	N/A	Pass
38	0.000	0.048	N/A	0.000	0.073	N/A	Pass
39	0.001	0.058	N/A	0.001	0.087	N/A	Pass
40	0.000	0.046	N/A	0.000	0.069	N/A	Pass

WALTEK



Voltage Source Verification Data (Run time)

Test category: Class-A (European limits) **Test Margin: 100**
Test date: 2023/10/23 **Start time: 17:15:30** **End time: 17:18:11**
Test duration (min): 2.5 **Data file name: H-000739.cts_data**

Test Result: Pass **Source qualification: Normal**

Highest parameter values during test:

Voltage (Vrms): 230.07	Frequency(Hz): 50.00
I_Peak (Amps): 0.122	I_RMS (Amps): 0.030
I_Fund (Amps): 0.005	Crest Factor: 4.090
Power (Watts): 1.2	Power Factor: 0.182

Harm#	Harmonics V-rms	Limit V-rms	% of Limit	Status
2	0.060	0.460	12.98	OK
3	0.505	2.070	24.40	OK
4	0.082	0.460	17.80	OK
5	0.061	0.920	6.61	OK
6	0.031	0.460	6.79	OK
7	0.027	0.690	3.98	OK
8	0.015	0.460	3.15	OK
9	0.013	0.460	2.93	OK
10	0.012	0.460	2.63	OK
11	0.010	0.230	4.40	OK
12	0.011	0.230	4.83	OK
13	0.014	0.230	6.10	OK
14	0.006	0.230	2.62	OK
15	0.011	0.230	4.68	OK
16	0.008	0.230	3.44	OK
17	0.016	0.230	7.04	OK
18	0.012	0.230	5.11	OK
19	0.010	0.230	4.36	OK
20	0.016	0.230	6.83	OK
21	0.009	0.230	3.83	OK
22	0.003	0.230	1.38	OK
23	0.006	0.230	2.50	OK
24	0.003	0.230	1.47	OK
25	0.007	0.230	3.06	OK
26	0.003	0.230	1.15	OK
27	0.007	0.230	3.22	OK
28	0.004	0.230	1.86	OK



Reference No.: WTF23X10222757W003

29	0.009	0.230	3.76	OK
30	0.004	0.230	1.75	OK
31	0.006	0.230	2.81	OK
32	0.003	0.230	1.13	OK
33	0.006	0.230	2.46	OK
34	0.003	0.230	1.14	OK
35	0.004	0.230	1.87	OK
36	0.002	0.230	1.05	OK
37	0.005	0.230	2.06	OK
38	0.002	0.230	1.04	OK
39	0.006	0.230	2.48	OK
40	0.008	0.230	3.30	OK

WALTEK



6. Voltage Fluctuation and Flicker

6.1 Test Setup Block Diagram

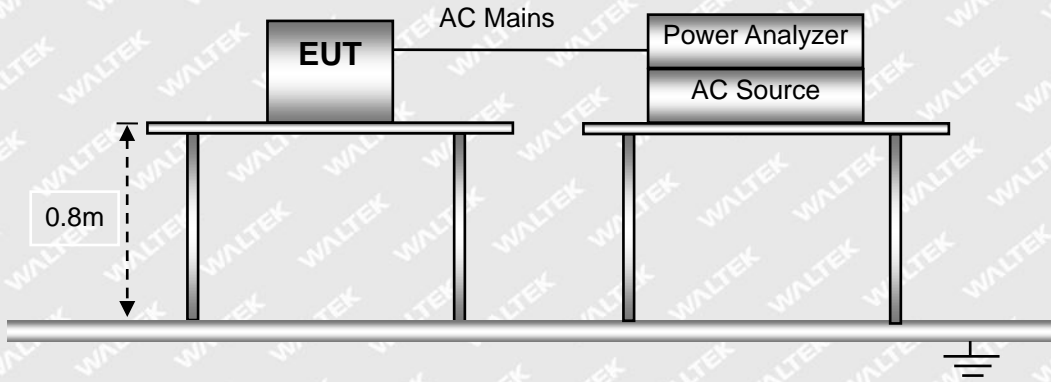

6.2 Test Standards

EN 61000-3-3, Limit: Clause 5.

6.3 Environmental Conditions

Temperature:	26 °C
Relative Humidity:	55%
ATM Pressure:	1015 mbar

6.4 Voltage Fluctuation and Flicker Test Data



Test mode:	TM1(worst case)
------------	-----------------

Test Result: Pass

Status: Test Completed

Pst_i and limit line

European Limits

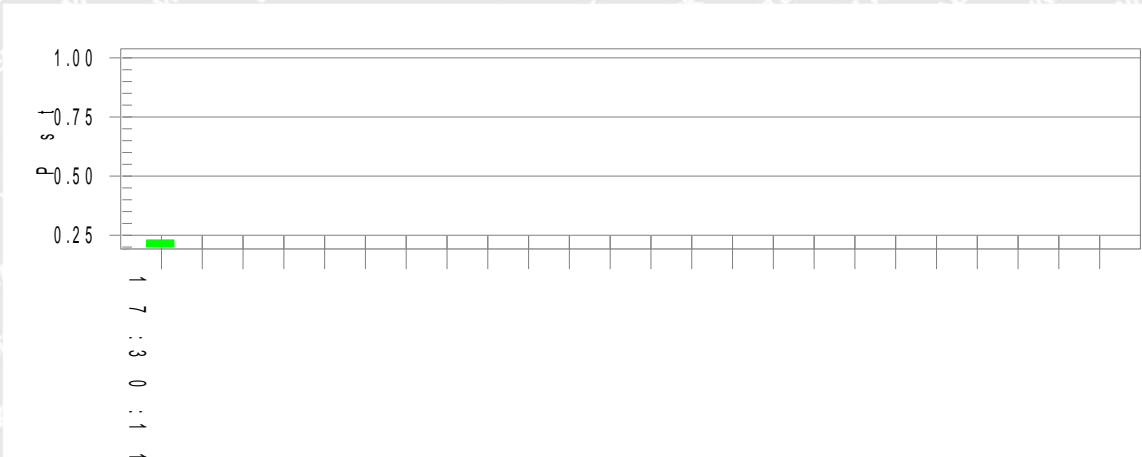

Plt and limit line



Parameter values recorded during the test:

Vrms at the end of test (Volt):	230.01		
Highest dt (%):		Test limit (%):	
T-max (mS):	0	Test limit (mS):	500.0 Pass
Highest dc (%):	0.00	Test limit (%):	3.30 Pass
Highest dmax (%):	0.00	Test limit (%):	4.00 Pass
Highest Pst (10 min. period):	0.230	Test limit:	1.000 Pass
Highest Plt (2 hr. period):	0.101	Test limit:	0.650 Pass



7. Electrostatic Discharge (ESD)

7.1 Test Setup Block Diagram

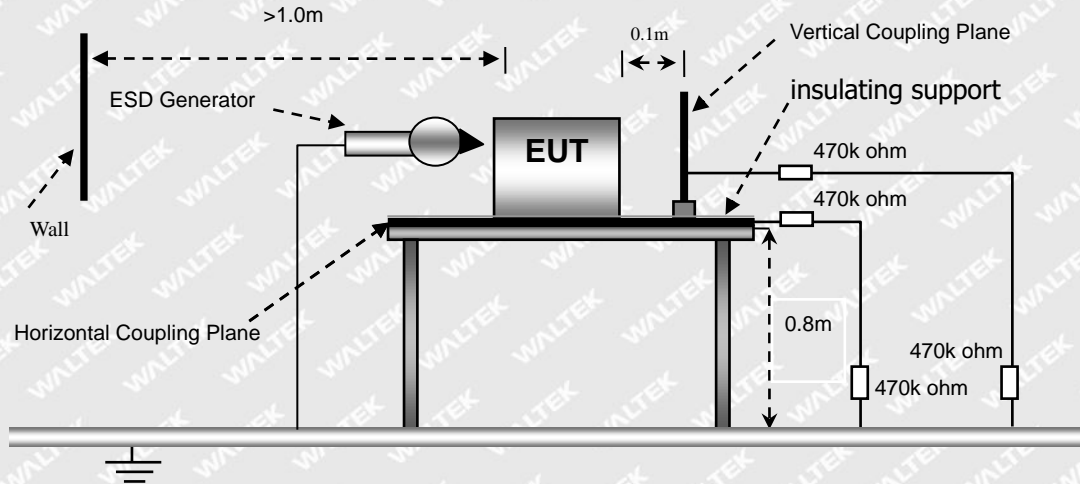

7.2 Test Performance

Required Performance Criterion:	B
Mode:	TM1-TM2
Note: TM2 for TT, TR	

7.3 Environmental Conditions

Temperature:	26 °C
Relative Humidity:	55%
ATM Pressure:	1011 mbar

7.4 Electrostatic Discharge Immunity Test Data



Test mode	TM1-TM2							
	Test Levels (kV)							
Test Points	-2	+2	-4	+4	-6	+6	-8	+8
Air Discharge								
USB Port	A	A	A	A	A	A	A	A
Gap	A	A	A	A	A	A	A	A
Button	A	A	A	A	A	A	A	A
Enclosure	A	A	A	A	A	A	A	A
Direct Contact Discharge								
USB Port	A	A	A	A	/	/	/	/
Indirect Contact Discharge								
HCP (6 Sides)	A	A	A	A	/	/	/	/
VCP (4 Sides)	A	A	A	A	/	/	/	/

Test Result: Pass





8. Radio Frequency Electromagnetic Field (R/S)

8.1 Test Setup Block Diagram

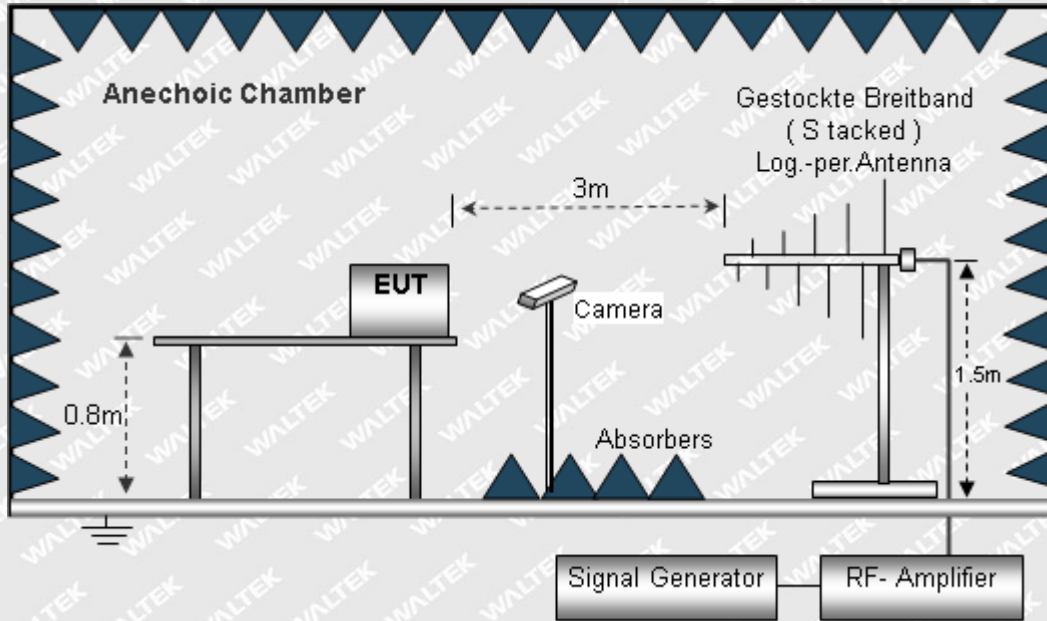

8.2 Test Performance

Required Performance Criterion:	A
Mode:	TM1-TM2
Note: TM2 for CT,CR	

8.3 Environmental Conditions

Temperature:	25 °C
Relative Humidity:	52%
ATM Pressure:	1010 mbar

8.4 Continuous Radiated Disturbances Test Data

Frequency step: 1% of fundamental

Dwell time: 1 second

Modulation: AM by 1kHz sine wave with 80% modulation depth



Test mode		TM1-TM2							
Frequency Range(MHz)	Field (V/m)	Front		Rear		Left Side		Right Side	
		VERT	HORI	VERT	HORI	VERT	HORI	VERT	HORI
80-1000	3	A	A	A	A	A	A	A	A
1000-3000	3	A	A	A	A	A	A	A	A
3000-6000	3	A	A	A	A	A	A	A	A

Test Result: Pass

WALTEK

9. Fast Transients, Common Mode (EFT)

9.1 Test Setup Block Diagram

For AC Mains or DC Ports:

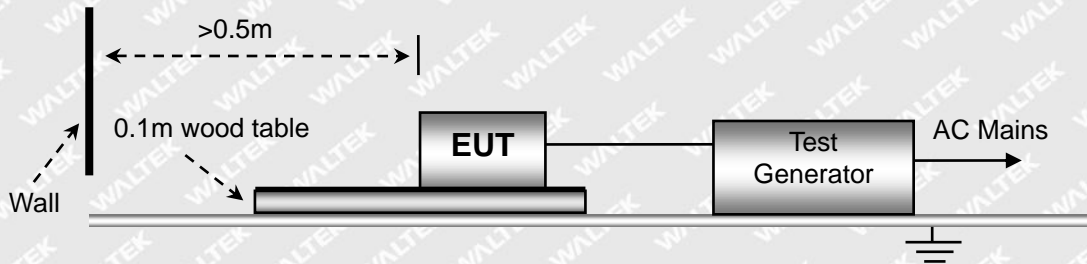

For Signal or Telecommunication Ports:

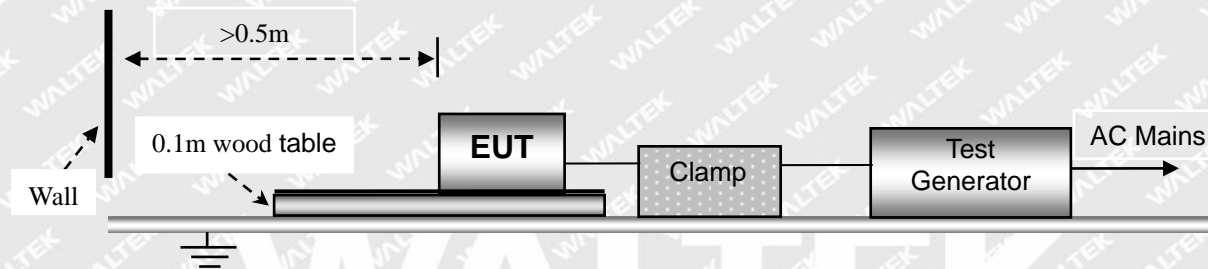

9.2 Test Performance

Required Performance Criterion:	B
Mode:	TM1-TM2
Note: TM2 for TT, TR	

9.3 Environmental Conditions

Temperature:	22 °C
Relative Humidity:	53%
ATM Pressure:	1011 mbar

9.4 Electrical Fast Transients Test Data



Test Mode		TM1-TM2							
Test Line		Test Levels (kV)							
		+0.5	-0.5	+1.0	-1.0	+2.0	-2.0	+4.0	-4.0
AC Main Power port	L	A	A	A	A	/	/	/	/
	N	A	A	A	A	/	/	/	/
	PE	/	/	/	/	/	/	/	/
	L-N	A	A	A	A	/	/	/	/
	L-PE	/	/	/	/	/	/	/	/
	N-PE	/	/	/	/	/	/	/	/
	L-N-PE	/	/	/	/	/	/	/	/
Signal ports	/	/	/	/	/	/	/	/	

Test Result: Pass





10. Surges

10.1 Test Setup Block Diagram

For AC Mains or DC Ports:

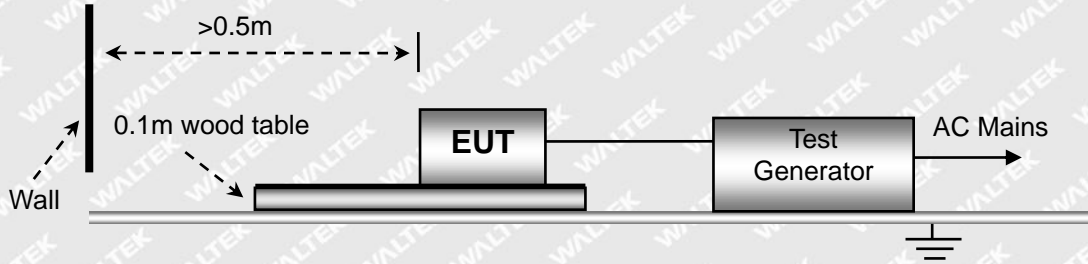

For Signal or Telecommunication Ports:

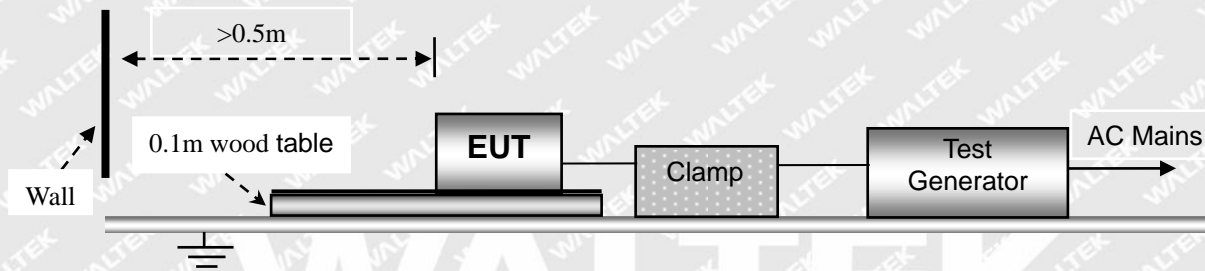

10.2 Test Performance

Required Performance Criterion:	B
Mode:	TM1-TM2
Note:TM2 for TT,TR	

10.3 Environmental Conditions

Temperature:	25 °C
Relative Humidity:	53%
ATM Pressure:	1011 mbar

10.4 Surge Test Data



Test Mode	TM1-TM2			
Voltage	Poll	Path	Pass	Fail
0.5kV	±	L-N	A	/
1kV	±	L-N	A	/
2kV	±	L-N, L-PE, N-PE	/	/
4kV	±	L-N, L-PE, N-PE	/	/

Test Result: Pass

WALTEK



11. Radio Frequency, Common Mode (C/S)

11.1 Test Setup Block Diagram

For AC Mains or DC Input:

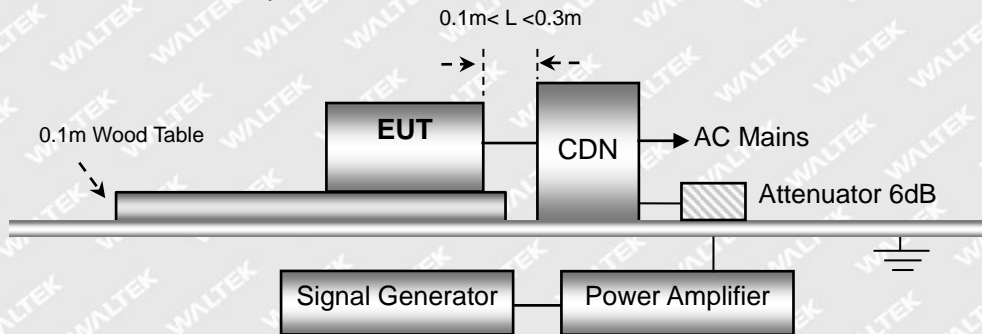

For Signal or Telecommunication Ports:

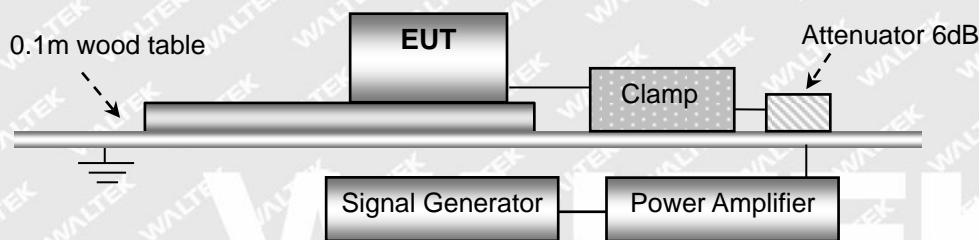

11.2 Test Performance

Required Performance Criterion:	A
Mode:	TM1-TM2
Note:	TM2 for CT,CR

11.3 Environmental Conditions

Temperature:	25 °C
Relative Humidity:	53%
ATM Pressure:	1011 mbar

11.4 Continuous Conducted Disturbances Test Data

Sweep frequency range: 150kHz~80MHz

Frequency step: 1% of fundamental

Dwell time: 1 second



Test Mode		TM1-TM2		
Level	Voltage (V) (rms, unmodulated)	Modulation:	Pass	Fail
1	1	AM 80%, 1kHz sinewave	/	/
2	3	AM 80%, 1kHz sinewave	A	/
3	10	AM 80%, 1kHz sinewave	/	/
X	Special	/	/	/

Test Result: Pass

WALTEK



12. Voltage Dips and Interruptions

12.1 Test Setup Block Diagram

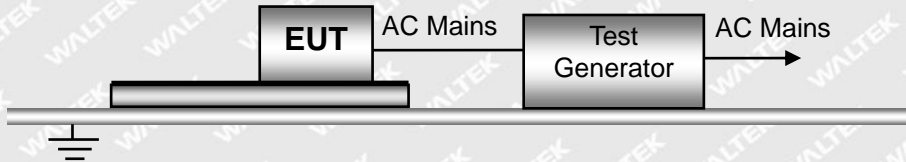

12.2 Test Performance

Required Performance Criterion:	B for voltage dip/ C for voltage interruption
Mode:	TM1-TM2
Note: TM2 for TT, TR	

12.3 Environmental Conditions

Temperature:	25 °C
Relative Humidity:	50%
ATM Pressure:	1011 mbar

12.4 Voltage Dips And Interruptions Test Data

U: Voltage dips in % U_T (U_T is rated voltage for the EUT)

T: Test duration

Level	U	T	Phase Angle	N	Pass	Fail
1	100%	10ms	0/90/180/270	3	A	/
2	100%	20ms	0/90/180/270	3	B	/
3	30%	500ms	0/90/180/270	3	B	/
4	100%	5000ms	0/90/180/270	3	C	/

Test Result: Pass



EXHIBIT 1 - EUT PHOTOGRAPHS

Please refer to "ANNEX".

WALTEK



EXHIBIT 2 - TEST SETUP PHOTOGRAPHS

**Conducted Emission
Test Setup**



**Radiation Emission
Test View(30MHz to
1GHz)**





**Radiation Emission
Test Setup (Above
1GHz)**

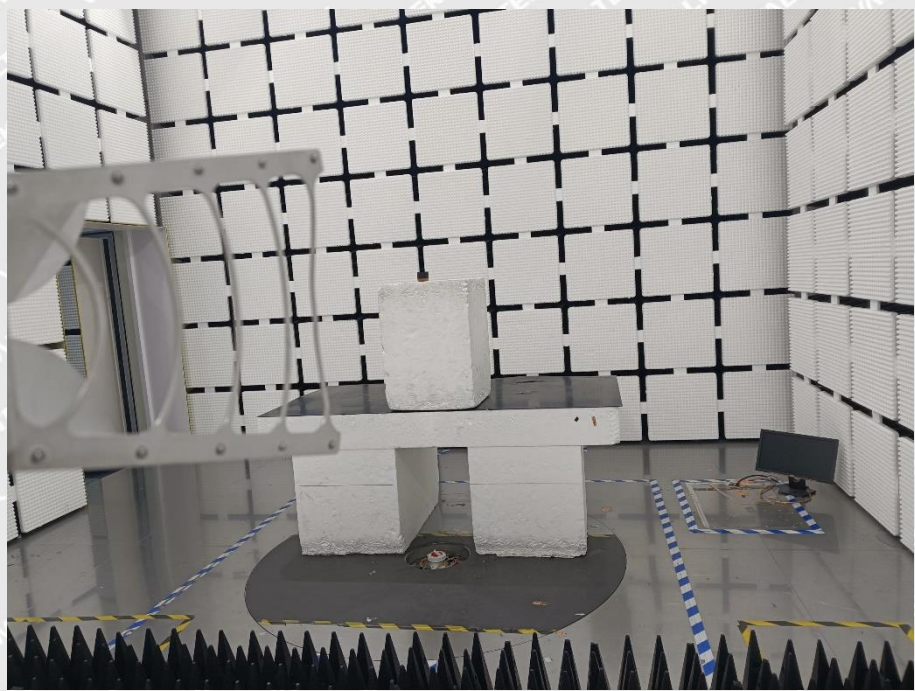

**Harmonic/Flicker Test
View**





ESD Test View



R/S Test View

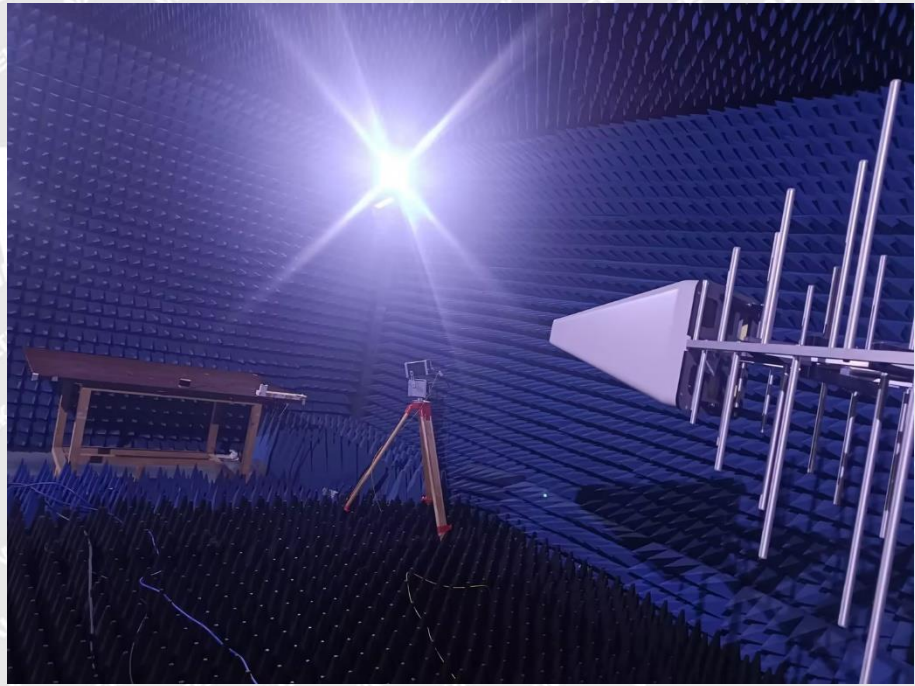



EFT/ Surges/ Dips and Interruptions Test View



CS Test View



**** END OF REPORT ****