



TEST REPORT

Report No.: STSGZ2310263030E

Date: 30-Nov-2023

Page 1 of 40

Applicant : Mid Ocean Brands B.V.

Address: 7/F., Kings Tower, 111 King Lam Street, Cheung Sha Wan, Kowloon, Hong Kong

The following sample(s) and sample information was/were submitted and identified by client as:

Product Name: Rechargeable torch including hand strap

Model/Style/Item #: MO2137

Receiving Date: 26-Oct-2023

Test Period: From 26-Oct-2023 to 31-Oct-2023

Add Information: -

Report Summary

#	Test item(s)	Reference Standard/Method	Result
1	EMC test - The Council EMC directive 2014/30/EU	EN IEC 55015:2019+A11:2020, EN 61547:2009	PASS

*****Please refer to the following page for detailed results*****

Signed for and on behalf of STS

Mark Mai
(Technical Director)



This report is issued by the company in accordance with the requirements of the "Conditions of Issuance of Test Reports" printed in the attached page. Unless otherwise stated, the results presented in this report only apply to the samples tested this time. Partial reproduction of this report is not allowed unless approved by the company in writing.



TEST REPORT

Report No.: STSGZ2310263030E

Date: 30-Nov-2023

Page 2 of 40

Result:

1. GENERAL INFORMATION

1.1 Description of Device (EUT)

Description	:	Rechargeable torch including hand strap
Model Number	:	MO2137
Remark	:	N/A

1.2 Operational Mode(s) of EUT

Order Number	:	Test Mode(s)
1	:	ON
2	:	Charging
3	:	Charging+ON

1.3 Test Voltage(s) of EUT

Order Number	:	Test Voltage(s)
1	:	DC 3.7V by Battery
2	:	DC 5V by USB Port

This report is issued by the company in accordance with the requirements of the "Conditions of Issuance of Test Reports" printed in the attached page. Unless otherwise stated, the results presented in this report only apply to the samples tested this time. Partial reproduction of this report is not allowed unless approved by the company in writing.



TEST REPORT

Report No.: STSGZ2310263030E

Date: 30-Nov-2023

Page 3 of 40

2. DESCRIPTION OF TEST STANDARD

The intention of this publication is to establish uniform requirements for the radio disturbance level of the equipment contained in the scope, to fix limits of disturbance, to describe methods of measurement and to standardize operating conditions and interpretation of results.

The following referenced standard are indispensable for the application of this report.

Referenced Description below:

EN IEC 55015:2019+A11:2020

Limits and methods of measurement of radio disturbance characteristics of electrical Torching and similar equipment.

EN IEC 61000-3-2:2019+A1:2021

Limits for harmonic current emissions (equipment input current ≤ 16 A per phase). EN 61000-3-

EN 61000-3-3:2013+A1:2019+A2:2021

Limitation of voltage changes, voltage fluctuations and flicker in public low-voltage supply systems, for equipment with rated current ≤ 16 A per phase and not subject to conditional connection.

EN 61547:2009

Equipment for general Rechargeable torch including hand strap purposes - EMC immunity requirements.

This report is issued by the company in accordance with the requirements of the "Conditions of Issuance of Test Reports" printed in the attached page. Unless otherwise stated, the results presented in this report only apply to the samples tested this time. Partial reproduction of this report is not allowed unless approved by the company in writing.

Guangzhou Depuhua Test Services Co. Ltd.

A301&A401, 3/F.&4/F., Xinghui Building, Guanqiao, Shilou, Panyu District, Guangzhou, Guangdong, China
Phone: +86 (0)20-6664 1688 Fax: +86 (0)20-6664 1699

e-mail: stsgz@stsapp.com

Web://www.stsgz.com



TEST REPORT

Report No.: STSGZ2310263030E

Date: 30-Nov-2023

Page 4 of 40

3. SUMMARY OF TEST RESULTS

EMISSION			
Test Item	Standard	Limits	Results
Conducted disturbance at mains terminals	EN IEC 55015:2019+A11:2020	---	PASS
Magnetic test	EN IEC 55015:2019+A11:2020	---	PASS
Radiated disturbance	EN IEC 55015:2019+A11:2020	---	PASS
*Harmonic current emissions	EN IEC 61000-3-2:2019 +A1:2021	Class C	PASS
Voltage fluctuations & flicker	EN 61000-3-3:2013+A1:2019 +A2:2021	---	N/A
IMMUNITY (EN 61547:2009)			
Test Item	Basic Standard	Performance Criteria	Results
Electrostatic discharge (ESD)	EN 61000-4-2:2009	B	PASS
Radio-frequency, Continuous radiated disturbance	EN IEC 61000-4-3:2020	A	PASS
Electrical fast transient (EFT)	EN 61000-4-4:2012	B	PASS
Surge (Input a.c. power ports)	EN 61000-4-5:2014+A1:2017	B	PASS
Radio-frequency, Continuous conducted disturbance	EN 61000-4-6:2014	A	PASS
Power frequency magnetic field	EN 61000-4-8:2010	A	PASS
Voltage dips, 100% reduction	EN IEC 61000-4-11:2020	B	N/A
Voltage dips, 30% reduction		C	N/A
N/A is an abbreviation for Not Applicable.			

This report is issued by the company in accordance with the requirements of the "Conditions of Issuance of Test Reports" printed in the attached page. Unless otherwise stated, the results presented in this report only apply to the samples tested this time. Partial reproduction of this report is not allowed unless approved by the company in writing.



TEST REPORT

Report No.: STSGZ2310263030E

Date: 30-Nov-2023

Page 5 of 40

4. BLOCK DIAGRAM OF TEST SETUP

The equipments are installed test to meet EN 55014-1 requirement and operating in a manner which tends to maximize its emission characteristics in a normal application. EUT was tested in normal configuration (Please See following Block diagrams)

4.1 Block Diagram of connection between EUT and simulation-EMI



(EUT:Rechargeable torch including hand strap)

4.2 Block Diagram of connection between EUT and simulation-EMS



(EUT:Rechargeable torch including hand strap))

This report is issued by the company in accordance with the requirements of the "Conditions of Issuance of Test Reports" printed in the attached page. Unless otherwise stated, the results presented in this report only apply to the samples tested this time. Partial reproduction of this report is not allowed unless approved by the company in writing.

Guangzhou Depuhua Test Services Co. Ltd.

A301&A401, 3/F.&4/F., Xinghui Building, Guanqiao, Shilou, Panyu District, Guangzhou, Guangdong, China
Phone: +86 (0)20-6664 1688 Fax: +86 (0)20-6664 1699

e-mail: stsgz@ststapp.com

Web://www.stsgz.com

TEST REPORT

5. CONDUCTED DISTURBANCE AT MAINS TERMINALS TEST

5.1 Configuration of Test System

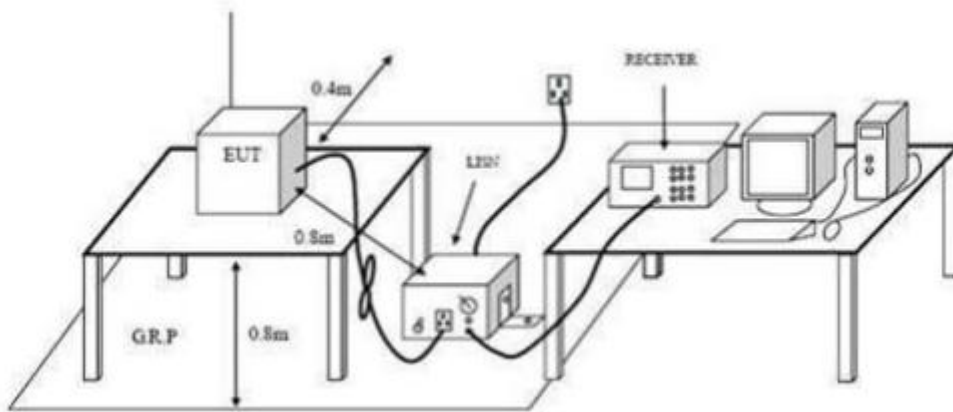

5.2 Test Standard

EN IEC 55015:2019+A11:2020

5.3 Power Line Conducted Disturbance at Mains Terminals Limit

Frequency (MHz)	Maximum RF Line Voltage	
	Quasi-Peak Level dB(μ V)	Average Level dB(μ V)
0.009 ~ 0.05	110	-
0.05 ~ 0.15	90 to 80*	-
0.15 ~ 0.50	66 to 56*	56 to 46*
0.50 ~ 5.00	56	46
5.00 ~ 30.00	60	50

Notes: 1. At the transition frequency, the lower limit applies.

2. *The limit decreases linearly with the logarithm of the frequency in the Frequency in the ranges 50KHz to 150KHz and 150KHz to 0.5MHz.



TEST REPORT

Report No.: STSGZ2310263030E

Date: 30-Nov-2023

Page 7 of 40

5.4 Test Procedure

The EUT was placed on a non-metallic table, 80cm above the ground plane. The EUT Power connected to the power mains through a line impedance stabilization network (L.I.S.N. 1#). This provided a 50-ohm coupling impedance for the EUT (Please refer to the block diagram of the test setup and photographs). The other peripheral devices power cord connected to the power mains through a line impedance stabilization network (L.I.S.N.#2). Both sides of power line were checked for maximum conducted interference. In order to find the maximum emission, the relative positions of equipments and all of the interface cables were changed according to EN IEC 55015 on conducted Disturbance test.

The bandwidth setting on the test receiver is 200Hz(frequency range from 9KHz to 150KHz) and 9KHz (frequency range from 150KHz to 30MHz)

The test result are reported on Section 5.5.

5.5. Conducted Disturbance at Mains Terminals Test Results

5.5.1. Test Results: **PASS**

5.5.2. If the average limit is met when using a quasi-peak detector, the EUT shall be deemed to meet both limits and measurement with average detector is unnecessary.

5.5.3. Emission Level= Correct Factor + Reading Level.

5.5.4. The test data and the scanning waveform are attached within Appendix I.

Note : All test modes are performed, only the worst case is recorded in this report.

TEST REPORT

6. MAGNETIC TEST

6.1 Configuration of Test System

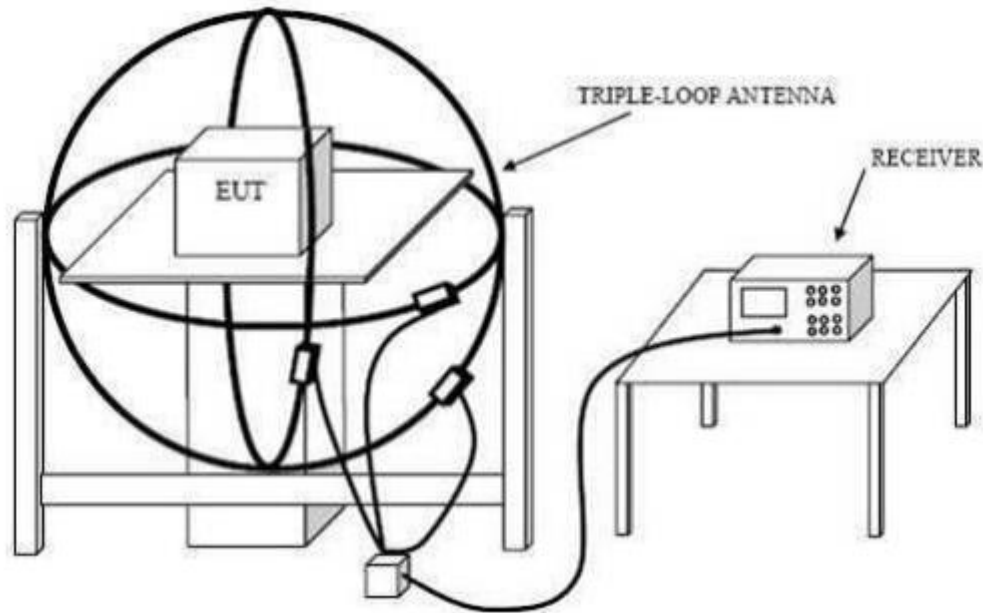

6.2 Test Standard

EN IEC 55015:2019+A11:2020

6.3 Radiated Disturbance Limit

Frequency (MHz)	Limits for loop diameter (dBuA)	
	2m	
0.009~0.07	88	
0.07~0.15	88~58*	
0.15~3.00	58~22*	
3.00~30.0	22	

Note: 1. At the transition frequency the lower limit applies.
 2. *decreasing linearly with logarithm of the frequency.

TEST REPORT

6.4 Test Procedure

The EUT is placed on a wood table in the center of a loop antenna. The induced current in the loop antenna is measured by means of a current probe and the test receiver. Three field components are checked by means of a coax switch.

The frequency range from 9 KHz to 30MHz is investigated. The receiver is measured with the quasi-peak detector. For frequency band 9 KHz to 150 KHz, the bandwidth of the field strength meter (R&S test receiver ESCI) is set at 200Hz. For frequency band 150 KHz to 30MHz, the bandwidth is set at 9 KHz.

The test result are reported on Section 6.5.

6.5. Radiated Disturbance Test Results

6.5.1. Test Results: **PASS**

7. RADIATED DISTURBANCE TEST

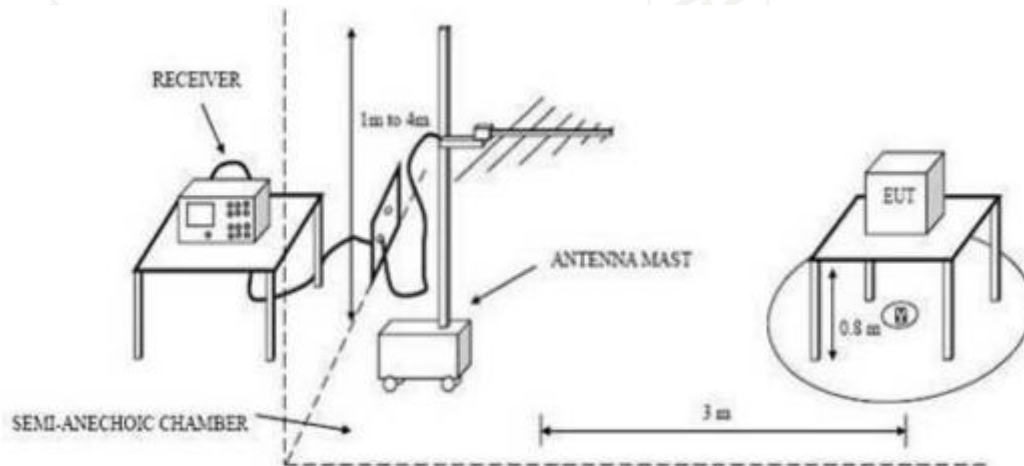

7.2. Test Standard

EN IEC 55015:2019+A11:2020



TEST REPORT

Report No.: STSGZ2310263030E

Date: 30-Nov-2023

Page 10 of 40

7.3. Radiated Disturbance Limit

All emanations from devices or system, including any network of conductors and apparatus connected thereto, shall not exceed the level of field strengths specified below:

FREQUENCY (MHz)	DISTANCE (Meters)	FIELD STRENGTHS LIMITS (dB μ V/m)
30 ~ 230	3	40
230 ~ 1000	3	47

Note: 1. The lower limit shall apply at the transition frequencies.

2. Distance refers to the distance in meters between the test antenna and the closed point of any part of the EUT.

7.4. Test Procedure

The EUT was placed on a non-metallic table, 80 cm above the ground plane inside a semi-anechoic chamber. An antenna was located 3m from the EUT on an adjustable mast. A pre-scan was first performed in order to find prominent radiated emissions. For final emissions measurements at each frequency of interest, the EUT were rotated and the antenna height was varied between 1m and 4m in order to maximize the emission. Measurements in both horizontal and vertical polarities were made and the data was recorded. In order to find the maximum emission, the relative positions of equipments and all of the interface cables were changed according to EN IEC 55015 on Radiated Disturbance test.

The bandwidth setting on the test receiver is 120 kHz.

The frequency range from 30MHz to 1000MHz is checked. The test result are reported on Section 7.5.

7.5. Radiated Disturbance Test Results

7.5.1. Test Results: **PASS**

7.5.2. Emission Level= Correct Factor + Reading Level.

7.5.3. All reading are Quasi-Peak values.

7.5.4. The test data and the scanning waveform are attached within Appendix II.

Note : All test modes are performed, only the worst case is recorded in this report.

TEST REPORT

Report No.: STSGZ2310263030E

Date: 30-Nov-2023

Page 11 of 40

8. HARMONIC CURRENT TEST

8.1. Configuration of Test System

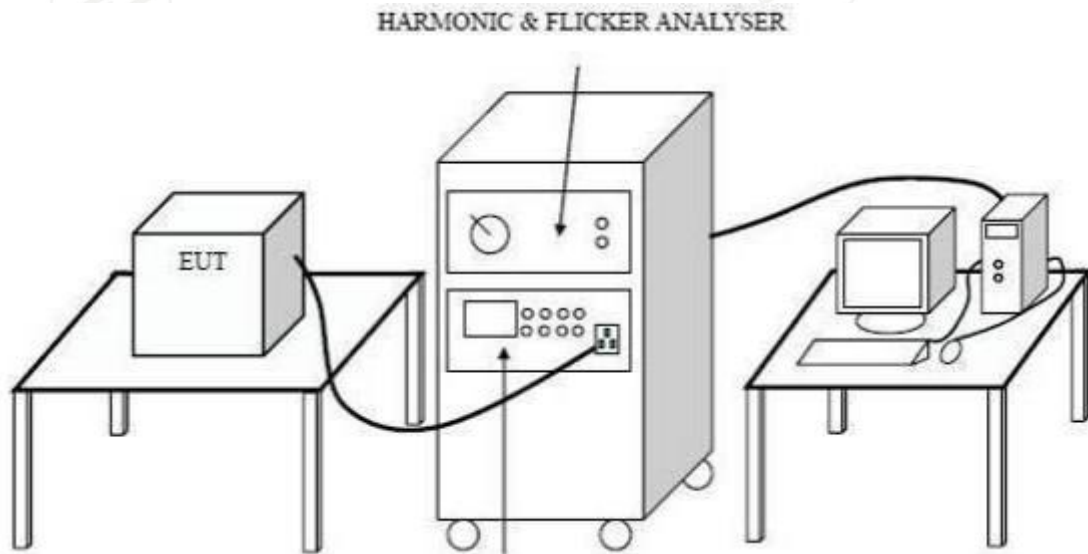

8.2. Test Standard

EN IEC 61000-3-2:2019+A1:2021; Class C



TEST REPORT

Report No.: STSGZ2310263030E

Date: 30-Nov-2023

Page 12 of 40

8.3. Test Limits

For Class C equipment, the harmonics of the input current shall not exceed the values given in below:

Harmonic order h	Maximum permissible harmonic current expressed as a percentage of the input current at the fundamental frequency %
2	2
3	$30 \cdot \lambda^*$
5	10
7	7
9	5
$11 \leq h \leq 39$ (odd harmonics only)	3

* λ is the circuit power factor

8.4. Test Results

8.4.1. Test Results: N/A

9. VOLTAGE FLUCTUATIONS & FLICKER TEST

9.1. Configuration of Test System

Same as Section 8.1.

9.2. Test Standard

EN 61000-3-3:2013+A1:2019+A2:2021

9.3. Test Limits

The limits shall be applicable to voltage fluctuations and flicker at the supply terminals of the equipment under test, the following limits apply:

the value of Pst shall not be greater than 1.0;

the value of Plt shall not be greater than 0.65;

the value of d(t) during a voltage change shall not exceed 3.3% for more than 500ms;

the relative steady-state voltage change, dc, shall not exceed 3.3%;

the maximum relative voltage change dmax, shall not exceed

a) 4% without additional conditions;

b) 6% for equipment which is:

Switched manually, or

Switched automatically more frequently than twice per day, and also has either a delayed restart (the delay being not less than a few tens of seconds), or manual restart, after a

This report is issued by the company in accordance with the requirements of the "Conditions of Issuance of Test Reports" printed in the attached page. Unless otherwise stated, the results presented in this report only apply to the samples tested this time. Partial reproduction of this report is not allowed unless approved by the company in writing.



TEST REPORT

Report No.: STSGZ2310263030E

Date: 30-Nov-2023

Page 13 of 40

power supply interruption.

c) 7% for equipment which is

Attended whilst in use (for example: hair dryers, vacuum cleaners, kitchen equipment such as mixers, garden equipment such as lawn mowers, portable tools such as electric drills), or switched on automatically, or is intended to be switched on manually, no more than twice per day, and also has either a delayed restart (the delay being not less than a few tens of seconds) or manual restart, after a power supply interruption.

9.4. Test Results: N/A

10. IMMUNITY PERFORMANCE CRITERIA

The test results shall be classified in terms of the loss of function or degradation of performance of the equipment under test, relative to a performance level by its manufacturer or the requestor of the test, or the agreed between the manufacturer and the purchaser of the product.

Definition related to the performance level:

Based on the used product standard

Based on the declaration of the manufacturer, requestor or purchaser

Criterion A:

During the test no change of the luminous intensity shall be observed and the regulating control, if any, shall operate during the test as intended.

Criterion B:

During the test the luminous intensity may change to any value. After the test the luminous intensity shall be restored to its initial value within 1 min.

Regulating controls need not function during the test, but after the test the mode of the control shall be the same as before the test provided that during the test no mode changing commands were given.

Criterion C:

During and after the test any change of the luminous intensity is allowed and the lamp(s) may be extinguished. After the test, within 30 min, all functions shall return to normal if necessary by temporary interruption of the mains supply and/or operating the regulating control.

TEST REPORT

11. ELECTROSTATIC DISCHARGE IMMUNITY TEST

11.1 Configuration of Test System

11.1.1 Configuration of ESD Test System(Direct Discharge)

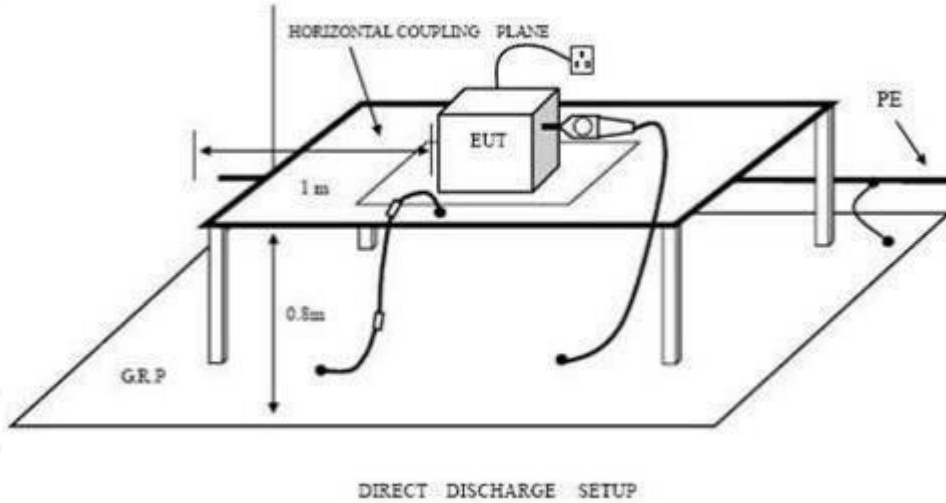

11.1.2. Configuration of ESD Test System(Indirect Discharge)

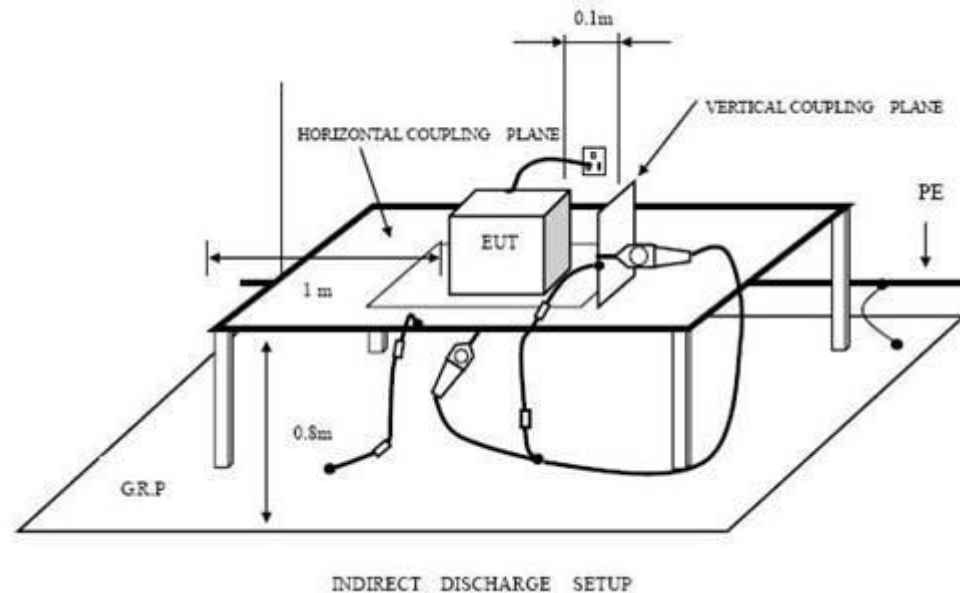

11.2 Test Standard

EN61547:2009 (EN 61000-4-2)

(Severity Level 3 for Air Discharge at 8KV, Severity Level 2 for Contact Discharge at 4KV)



TEST REPORT

Report No.: STSGZ2310263030E

Date: 30-Nov-2023

Page 15 of 40

11.3 Severity Levels and Performance Criterion

11.3.1 Severity level

Level	Test Voltage Contact Discharge (KV)	Test Voltage Air Discharge (KV)
1.	2	2
2.	4	4
3.	6	8
4.	8	15
X	Special	Special

11.3.2 Performance criterion : **B**

11.4 Test Procedure

11.4.1. Air Discharge:

The test was applied on non-conductive surfaces of EUT. The round discharge tip of the discharge electrode was approached as fast as possible to touch the EUT. After each discharge, the discharge electrode was removed from the EUT. The generator was re-triggered for a new single discharge and repeated 20 times for each pre-selected test point. This procedure was repeated until all the air discharge completed

11.4.2. Contact Discharge:

All the procedure was same as Section 11.4.1. except that the tip of the discharge electrode shall touch the EUT before the discharge switch was operated.

11.4.3. Indirect discharge for horizontal coupling plane

At least 20 single discharges were applied to the horizontal coupling plane, at points on each side of the EUT. The discharge electrode positions vertically at a distance of 0.1m from the EUT and with the discharge electrode touching the coupling plane.

11.4.4. Indirect discharge for vertical coupling plane

At least 20 single discharge were applied to the center of one vertical edge of the coupling plane. The coupling plane, of dimensions 0.5m X 0.5m, was placed parallel to, and positioned at a distance of 0.1m from the EUT. Discharges were applied to the coupling plane, with this plane in sufficient different positions that the four faces of the EUT are completely illuminated.

11.5 Test Results

11.5.1 Test Results: **PASS**

11.5.2 Test data on the following pages.

This report is issued by the company in accordance with the requirements of the "Conditions of Issuance of Test Reports" printed in the attached page. Unless otherwise stated, the results presented in this report only apply to the samples tested this time. Partial reproduction of this report is not allowed unless approved by the company in writing.



TEST REPORT

Report No.: STSGZ2310263030E

Date: 30-Nov-2023

Page 16 of 40

Electrostatic Discharge Test Results

Test Voltage :	1&2	Test Date:	Oct.27,2023
Test Mode :	1&2&3	Criterion :	B
Temperature:	26.5°C	Humidity:	60%
Air Discharge: ±2,4 and 8KV		# For Air Discharge each Point Positive 10 times and negative 10 times discharge.	
Contact Discharge: ±4KV		# For Contact Discharge each point positive 10 times and negative 10 times discharge	
Test Results Description			
Location	Kind A-Air Discharge C-Contact Discharge	Result	
Gaps	A	PASS	
Switch	C	PASS	
HCP	A	PASS	
Port	C	PASS	
VCP of Front	C	PASS	
VCP of Rear	C	PASS	
VCP of Left	C	PASS	
VCP of Right	C	PASS	
Remark :			

Discharge was considered on Contact and Air and Horizontal Coupling Plane (HCP) and Vertical Coupling Plane (VCP).

This report is issued by the company in accordance with the requirements of the "Conditions of Issuance of Test Reports" printed in the attached page. Unless otherwise stated, the results presented in this report only apply to the samples tested this time. Partial reproduction of this report is not allowed unless approved by the company in writing.

Guangzhou Depuhua Test Services Co. Ltd.

A301&A401, 3/F.&4/F., Xinghui Building, Guanqiao, Shilou, Panyu District, Guangzhou, Guangdong, China
Phone: +86 (0)20-6664 1688 Fax: +86 (0)20-6664 1699

Web://www.stsgz.com

e-mail: stsgz@stsapp.com

TEST REPORT

12. RF FIELD STRENGTH SUSCEPTIBILITY TEST

12.1 Configuration of Test System

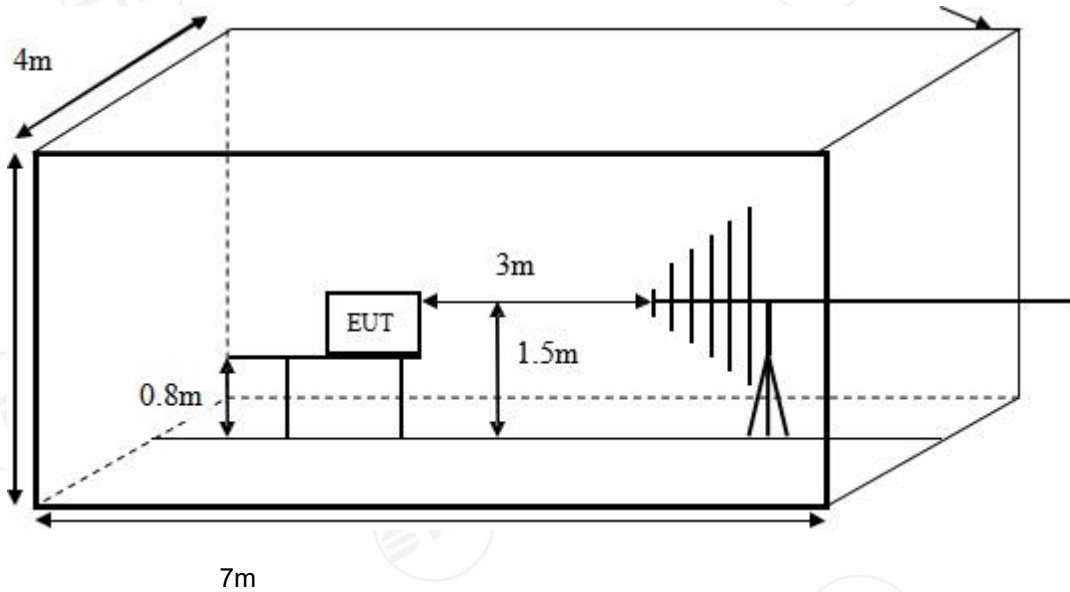

12.2 Test Standard

EN 61547:2009 (EN IEC 61000-4-3)
(Severity Level: 2 at 3V / m)

12.3 Severity Levels and Performance Criterion

12.3.1 Severity level

Level	Test Field Strength V/m
1.	1
2.	3
3.	10
X	Special

12.3.2 Performance criterion : A



TEST REPORT

Report No.: STSGZ2310263030E

Date: 30-Nov-2023

Page 18 of 40

12.4 Test Procedure

The EUT and its simulators are placed on a turn table which is 0.8 meter above the ground. The EUT is set 3 meters away from the transmitting antenna which is mounted on an antenna tower. Both horizontal and vertical polarization of the antenna is set on test. Each of the four sides of EUT must be faced this transmitting antenna and measured individually. In order to judge the EUT performance, a CCD camera is used to monitor the EUT.

All the scanning conditions are as follows :

Condition of Test

Remarks

- 1. Test Fielded Strength
- 2. Radiated Signal
- 3. Scanning Frequency
- 4. Sweeping time of radiated
- 5. Dwell Time

3 V/m (Severity Level 2)
80% amplitude modulated with a 1kHz sine wave
80 - 6000 MHz
0.0015 decade/s
1.5 Sec.

12.5 Test Results

12.5.1 Test Results: **PASS**

12.5.2 Test data on the following pages

This report is issued by the company in accordance with the requirements of the "Conditions of Issuance of Test Reports" printed in the attached page. Unless otherwise stated, the results presented in this report only apply to the samples tested this time. Partial reproduction of this report is not allowed unless approved by the company in writing.

Guangzhou Depuhua Test Services Co. Ltd.

A301&A401, 3/F.&4/F., Xinghui Building, Guanqiao, Shilou, Panyu District, Guangzhou, Guangdong, China
Phone: +86 (0)20-6664 1688 Fax: +86 (0)20-6664 1699

e-mail: stsgz@stsapp.com

Web://www.stsgz.com



TEST REPORT

Report No.: STSGZ2310263030E

Date: 30-Nov-2023

Page 19 of 40

RF Field Strength Susceptibility Test Results

Test Voltage :	1&2	Test Date:	Oct.27,2023
Test Mode:	1&2&3	Frequency Range:	80-1000MHz
Field Strength :	3 V/m	Criterion :	A
Temperature:	26.5°C	Humidity:	60%
Modulation:	<input checked="" type="checkbox"/> AM <input type="checkbox"/> Pulse <input type="checkbox"/> none 1 kHz 80%		
Test Results Description			
Frequency Rang 1: 80MHz - 1000 MHz			
Steps	1%	1%	
	Horizontal	Vertical	
Front	PASS	PASS	
Right	PASS	PASS	
Rear	PASS	PASS	
Left	PASS	PASS	
Note: No function loss			

This report is issued by the company in accordance with the requirements of the "Conditions of Issuance of Test Reports" printed in the attached page. Unless otherwise stated, the results presented in this report only apply to the samples tested this time. Partial reproduction of this report is not allowed unless approved by the company in writing.

Guangzhou Depuhua Test Services Co. Ltd.

A301&A401, 3/F.&4/F., Xinghui Building, Guanqiao, Shilou, Panyu District, Guangzhou, Guangdong, China
Phone: +86 (0)20-6664 1688 Fax: +86 (0)20-6664 1699 Web://www.stsgz.com

e-mail: stsgz@stsapp.com

TEST REPORT

13. ELECTRICAL FAST TRANSIENT/BURST IMMUNITY TEST

13.1 Configuration of Test System

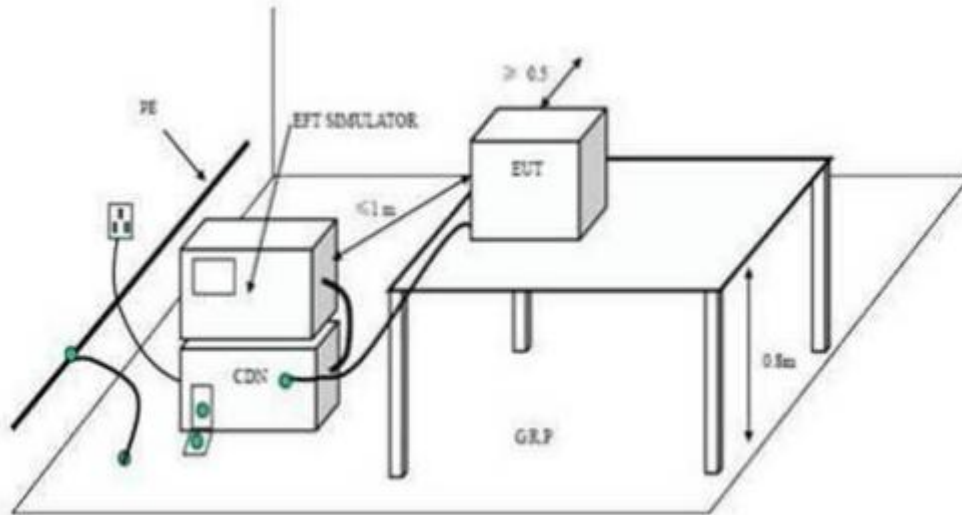

13.2 Test Standard

EN 61547:2009 (EN 61000-4-4)
(Severity Level 2 at 1KV)

13.3 Severity Levels and Performance Criterion

13.3.1 Severity level

Open Circuit Output Test Voltage $\pm 10\%$		
Level	On Power Supply Lines	On I/O (Input/Output) Signal data and control lines
1.	0.5 KV	0.25 KV
2.	1 KV	0.5 KV
3.	2 KV	1 KV
4.	4 KV	2 KV
X	Special	Special

13.3.2 Performance criterion : B

13.4 Test Procedure

The EUT and its simulators were placed on a the ground reference plane and were insulated from it by an wood support 0.1m + 0.01m thick. The ground reference plane was 1m*1m metallic sheet with 0.65mm minimum thickness. This reference ground plane was project beyond the EUT by at least 0.1m on all sides and the minimum distance between EUT and all other conductive structure, except the ground plane was more than 0.5m. All cables to the EUT was placed on the wood support, cables not subject to EFT/B was routed as far as possible from the cable under test to minimize the coupling between the cables.



TEST REPORT

Report No.: STSGZ2310263030E

Date: 30-Nov-2023

Page 21 of 40

13.4.1. For input and AC power ports:

The EUT was connected to the power mains by using a coupling device which couples the EFT interference signal to AC power lines. Both positive transients and negative transients of test voltage was applied during compliance test and the duration of the test can't less than 2mins.

13.4.2. For signal lines and control lines ports:

It's unnecessary to test.

13.4.3. For DC input and DC output power ports:

It's unnecessary to test.

13.5 Test Results

13.5.1 Test Results: **PASS**

13.5.2 Test data on the following pages.

Magnetic Field Immunity Test Results

Test Voltage :	2			Test Date:	Oct.27,2023				
Test Mode :	2&3			Criterion :	B				
Temperature:	26.5°C			Humidity:	60.0%				
Test Results Description									
Inject Line	Voltage KV	Inject Time(s)	Inject Method	Results	Inject Line	Voltage KV	Inject Time(s)	Inject Method	Results
L	±1	120	Direct	PASS					
N	±1	120	Direct	PASS					
L+N	±1	120	Direct	PASS					
Remark:									

This report is issued by the company in accordance with the requirements of the "Conditions of Issuance of Test Reports" printed in the attached page. Unless otherwise stated, the results presented in this report only apply to the samples tested this time. Partial reproduction of this report is not allowed unless approved by the company in writing.

TEST REPORT

14. SURGE TEST

14.1. Configuration of Test System

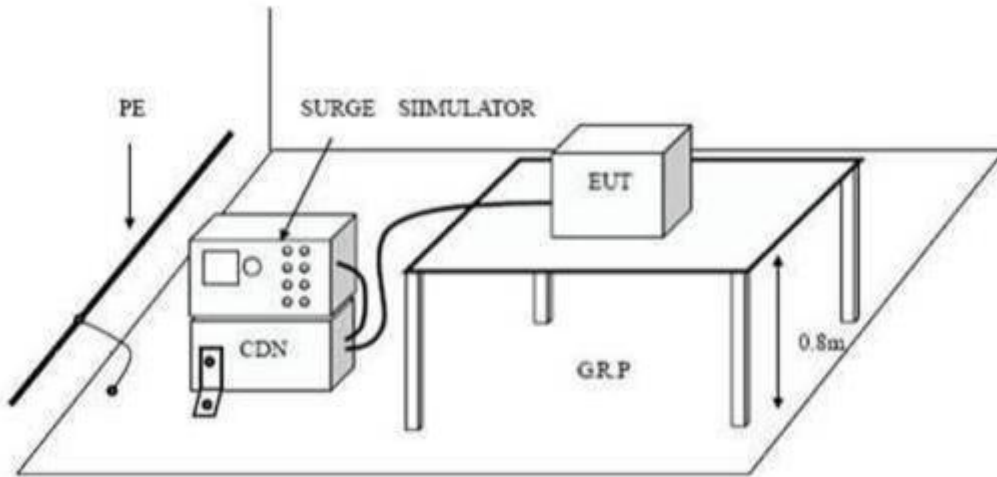

14.2. Test Standard

EN 61547:2009 (EN 61000-4-5)
 (Severity Level : Line to Line was Level 2 at 1KV
 Line to PE was Level 3 at 2KV)

14.3. Severity Levels and Performance Criterion

14.3.1. Severity level

Severity Level	Open-Circuit Test Voltage KV
1	0.5
2	1.0
3	2.0
4	4.0
*	Special

14.3.2. Performance criterion : C

14.4. Test Procedure

14.4.1. Set up the EUT and test generator as shown on Section 16.1.

14.4.2. For line to line coupling mode, provide a 0.5KV 1.2/50us voltage surge (at open-circuit condition) and 8/20us current surge to EUT selected points, and for active line / neutral line to ground are same except test level is 1KV.



TEST REPORT

Report No.: STSGZ2310263030E

Date: 30-Nov-2023

Page 23 of 40

14.4.3. At least 5 positive and 5 negative (polarity) tests with a maximum 1/min repetition rate are applied during test.

14.4.4. Different phase angles are done individually.

14.4.5. Record the EUT operating situation during compliance test and decide the EUT immunity criterion for above each test.

14.5. Test Results

14.5.1. Test Results: **PASS**

14.5.2. Test data on the following pages.

This report is issued by the company in accordance with the requirements of the "Conditions of Issuance of Test Reports" printed in the attached page. Unless otherwise stated, the results presented in this report only apply to the samples tested this time. Partial reproduction of this report is not allowed unless approved by the company in writing.

Guangzhou Depuhua Test Services Co. Ltd.

A301&A401, 3/F.&4/F., Xinghui Building, Guanqiao, Shilou, Panyu District, Guangzhou, Guangdong, China
Phone: +86 (0)20-6664 1688 Fax: +86 (0)20-6664 1699

e-mail: stsgz@stsapp.com

Web://www.stsgz.com

TEST REPORT

15. INJECTED CURRENTS SUSCEPTIBILITY TEST

15.1. Configuration of Test System

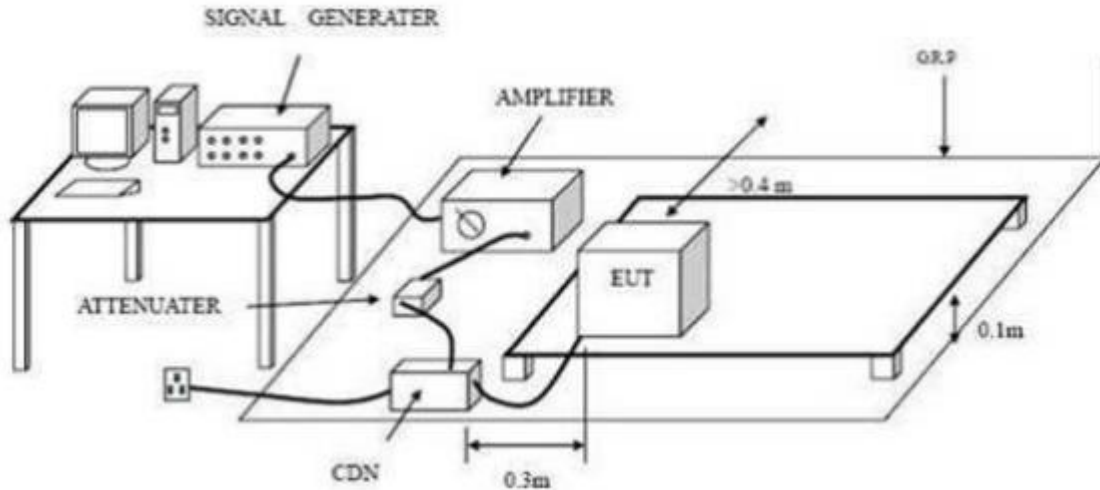

15.2. Test Standard

EN 61547:2009 (EN 61000-4-6)
(Severity Level 2 at 3V (r.m.s.) and frequency is from 0.15MHz to 80MHz)

15.3. Severity Levels and Performance Criterion

15.3.1. Severity level

Level	Voltage Level (e.m.f.) V
1.	1
2.	3
3.	10
X	Special

15.3.2. Performance criterion: A

15.4. Test Procedure

- 15.4.1. Set up the EUT, CDN and test generators as shown on Section 17.1.
- 15.4.2. Let the EUT work in test mode and test it.
- 15.4.3. The EUT are placed on an insulating support 0.1m high above a ground reference plane. CDN (coupling and decoupling device) is placed on the ground plane about 0.3m from EUT. Cables between CDN and EUT are as short as possible, and their height above the ground reference plane shall be between 30 and 50 mm (where possible).
- 15.4.4. The disturbance signal description below is injected to EUT through CDN.
- 15.4.5. The EUT operates within its operational mode(s) under intended climatic conditions after power on.



TEST REPORT

Report No.: STSGZ2310263030E

Date: 30-Nov-2023

Page 26 of 40

15.4.6. The frequency range is swept from 0.15MHz to 80MHz using 3V signal level, and with the disturbance signal 80% amplitude modulated with a 1KHz sine wave.

15.4.7. The rate of sweep shall not exceed 1.5×10^{-3} decades/s. Where the frequency is swept incrementally, the step size shall not exceed 1% of the start and thereafter 1% of the preceding frequency value.

15.4.8. Recording the EUT operating situation during compliance testing and decide the EUT immunity criterion.

15.5. Test Results

15.5.1. Test Results: **PASS**

15.5.2. Test data on the following pages.



TEST REPORT

Report No.: STSGZ2310263030E

Date: 30-Nov-2023

Page 27 of 40

Injected Currents Susceptibility Test Results

<i>Power Supply :</i>	2	<i>Test Date: :</i>	Oct.27,2023	
<i>Test Mode :</i>	2&3	<i>Criterion: :</i>	A	
<i>Temperature:</i>	26.5 °C	<i>Humidity:</i>	60.0%	
<i>Test Results Description</i>				
<i>Frequency Range (MHz)</i>	<i>Injected Position</i>	<i>Voltage Level (e.m.f.)</i>	<i>Criterion</i>	<i>Result</i>
0.15 ~ 80	AC Mains	3V(rms), Unmodulated	A	PASS
<i>Remark : No function loss</i>				

This report is issued by the company in accordance with the requirements of the "Conditions of Issuance of Test Reports" printed in the attached page. Unless otherwise stated, the results presented in this report only apply to the samples tested this time. Partial reproduction of this report is not allowed unless approved by the company in writing.

Guangzhou Depuhua Test Services Co. Ltd.

A301&A401, 3/F.&4/F., Xinghui Building, Guanqiao, Shilou, Panyu District, Guangzhou, Guangdong, China
Phone: +86 (0)20-6664 1688 Fax: +86 (0)20-6664 1699

e-mail: stsgz@stsapp.com

Web://www.stsgz.com

16. MAGNETIC FIELD IMMUNITY TEST

16.1. Configuration of Test System

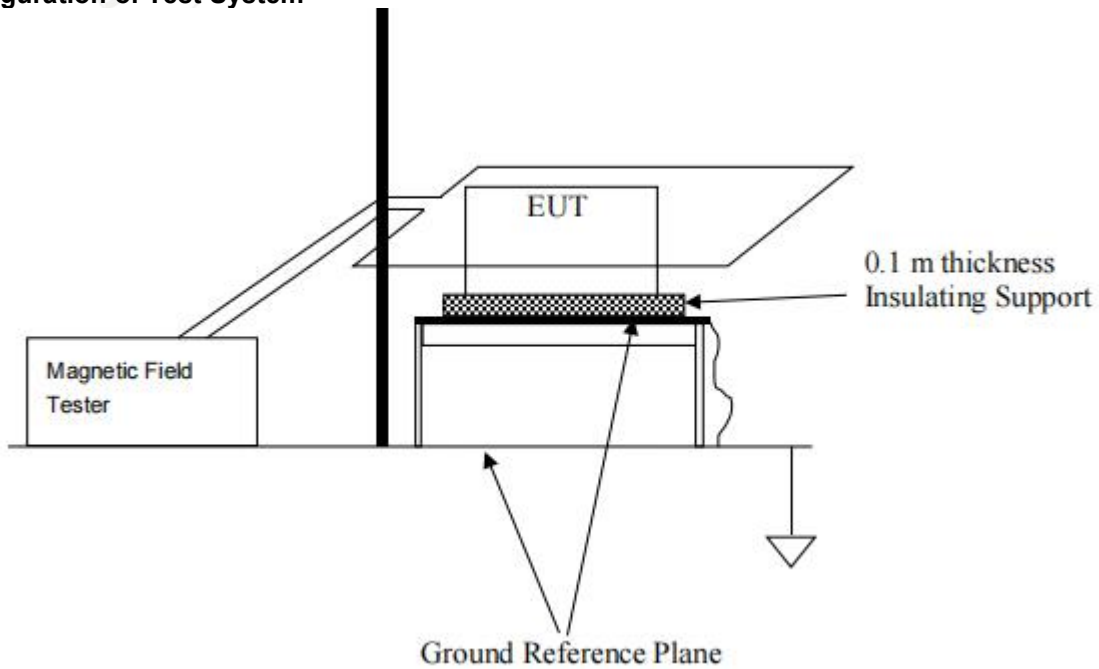

16.2. Test Standard

EN 61547:2009 (EN 61000-4-8)
(Severity Level 2 at 3A/m)

16.3. Severity Levels and Performance Criterion

16.3.1. Severity level

Level	Magnetic Field Strength A/m
1.	1
2.	3
3.	10
4.	30
5.	100
X.	Special



TEST REPORT

Report No.: STSGZ2310263030E

Date: 30-Nov-2023

Page 29 of 40

16.3.2.Performance criterion : A

16.4.Test Procedure

The EUT was subjected to the test magnetic field by using the induction coil of standard dimensions (1m*1m) and shown in Section 18.1. The induction coil was then rotated by 90° in order to expose the EUT to the test field with different orientations.

16.5.Test Results

16.5.1.Test Results: **PASS**

16.5.2.Test data on the following pages.

APPENDIX I

EUT:	Rechargeable torch including hand strap	M/N:	MO2137
Mode:	Charging+ON	Polarization:	L
Test by:	Dawn	Power:	DC 5V by USB Port
Temperature: / Humidity	26.5°C/ 60.0%	Test date:	2023-10-27

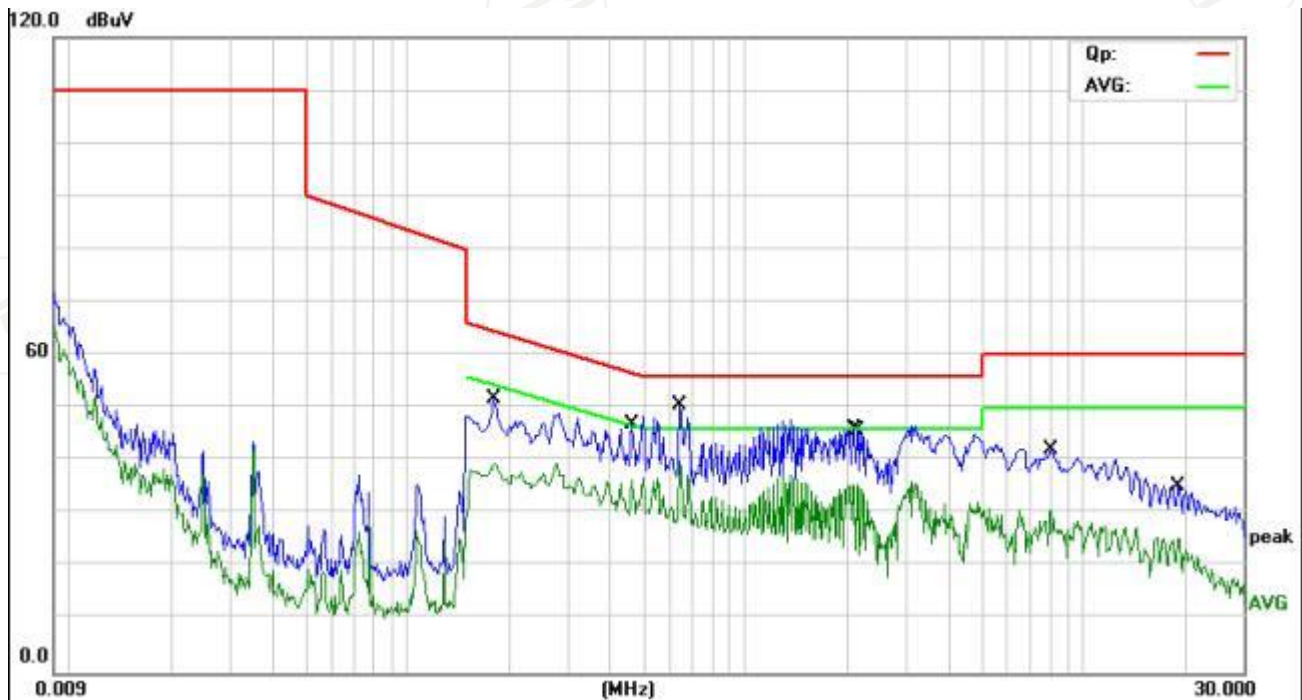

This report is issued by the company in accordance with the requirements of the "Conditions of Issuance of Test Reports" printed in the attached page. Unless otherwise stated, the results presented in this report only apply to the samples tested this time. Partial reproduction of this report is not allowed unless approved by the company in writing.

Guangzhou Depuhua Test Services Co. Ltd.

A301&A401, 3/F.&4/F., Xinghui Building, Guanqiao, Shilou, Panyu District, Guangzhou, Guangdong, China
Phone: +86 (0)20-6664 1688 Fax: +86 (0)20-6664 1699

e-mail: stsgz@ststapp.com

Web://www.stsgz.com



TEST REPORT

Report No.: STSGZ2310263030E

Date: 30-Nov-2023

Page 30 of 40

No.	Mk.	Freq.	Reading Level	Correct Factor	Measurement	Limit	Over	Detector	Comment
		MHz	dBuV	dB	dBuV	dBuV	dB		
1		0.1820	42.12	9.61	51.73	64.39	-12.66	QP	
2		0.1820	29.95	9.61	39.56	54.39	-14.83	AVG	
3		0.4660	37.42	9.59	47.01	56.58	-9.57	QP	
4		0.4660	26.91	9.59	36.50	46.58	-10.08	AVG	
5	*	0.6500	39.31	9.60	48.91	56.00	-7.09	QP	
6		0.6500	28.95	9.60	38.55	46.00	-7.45	AVG	
7		2.1220	36.41	9.60	46.01	56.00	-9.99	QP	
8		2.1580	25.94	9.60	35.54	46.00	-10.46	AVG	
9		8.0780	32.47	9.66	42.13	60.00	-17.87	QP	
10		8.0780	20.99	9.66	30.65	50.00	-19.35	AVG	
11		19.1900	15.60	9.73	25.33	50.00	-24.67	AVG	
12		19.3380	25.60	9.73	35.33	60.00	-24.67	QP	

*:Maximum data x:Over limit !:over margin

This report is issued by the company in accordance with the requirements of the "Conditions of Issuance of Test Reports" printed in the attached page. Unless otherwise stated, the results presented in this report only apply to the samples tested this time. Partial reproduction of this report is not allowed unless approved by the company in writing.

Guangzhou Depuhua Test Services Co. Ltd.

A301&A401, 3/F.&4/F., Xinghui Building, Guanqiao, Shilou, Panyu District, Guangzhou, Guangdong, China
Phone: +86 (0)20-6664 1688 Fax: +86 (0)20-6664 1699 Web://www.stsgz.com

e-mail: stsgz@stsapp.com



TEST REPORT

Report No.: STSGZ2310263030E

Date: 30-Nov-2023

Page 31 of 40

EUT:	Rechargeable torch including hand strap	M/N:	MO2137
Mode:	Charging+ON	Polarization:	N
Test by:	Dawn	Power:	DC 5V by USB Port
Temperature: / Humidity	26.5°C/ 60.0%	Test date:	2023-10-27

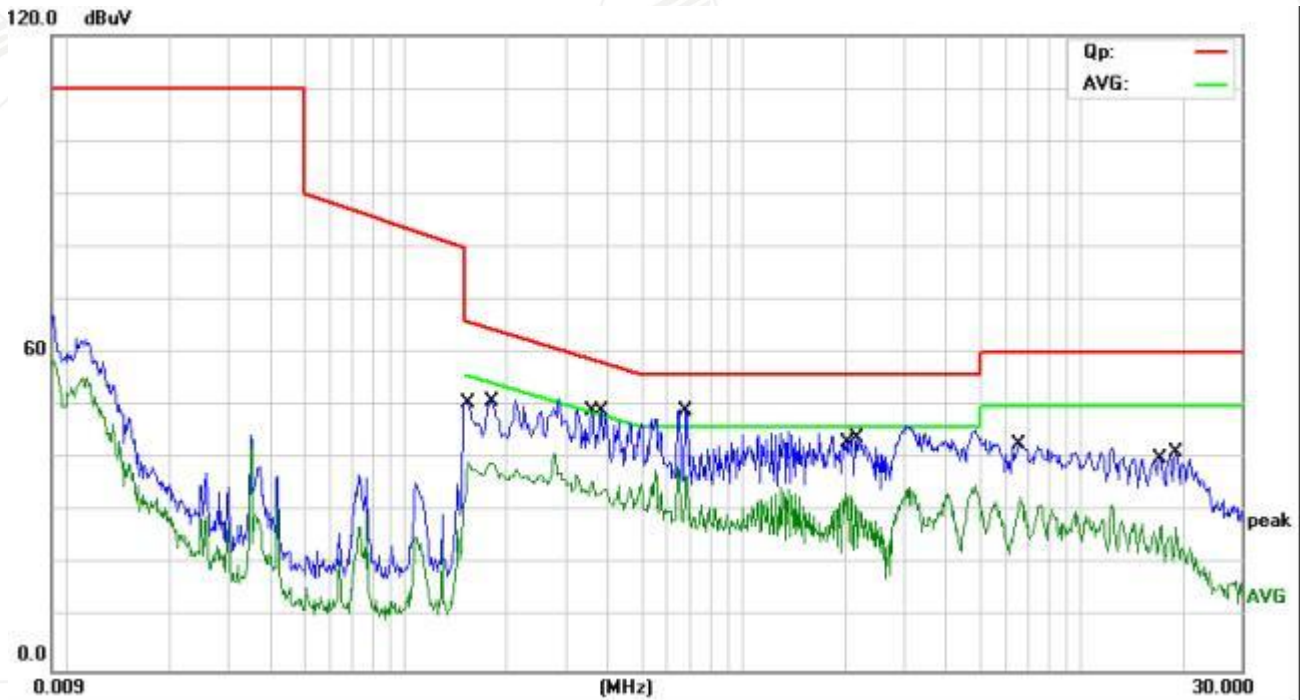

This report is issued by the company in accordance with the requirements of the "Conditions of Issuance of Test Reports" printed in the attached page. Unless otherwise stated, the results presented in this report only apply to the samples tested this time. Partial reproduction of this report is not allowed unless approved by the company in writing.

Guangzhou Depuhua Test Services Co. Ltd.

A301&A401, 3/F.&4/F., Xinghui Building, Guanqiao, Shilou, Panyu District, Guangzhou, Guangdong, China
Phone: +86 (0)20-6664 1688 Fax: +86 (0)20-6664 1699

e-mail: stsgz@stsapp.com

Web://www.stsgz.com



TEST REPORT

Report No.: STSGZ2310263030E

Date: 30-Nov-2023

Page 32 of 40

No.	Mk.	Freq.	Reading Level	Correct Factor	Measurement	Limit	Over	Detector	Comment
		MHz	dBuV	dB	dBuV	dBuV	dB		
1		0.1540	29.75	9.60	39.35	55.78	-16.43	AVG	
2		0.1780	41.14	9.61	50.75	64.58	-13.83	QP	
3		0.3580	26.29	9.59	35.88	48.77	-12.89	AVG	
4		0.3820	39.53	9.59	49.12	58.24	-9.12	QP	
5	*	0.6780	39.51	9.60	49.11	56.00	-6.89	QP	
6		0.6820	27.23	9.60	36.83	46.00	-9.17	AVG	
7		2.0140	23.78	9.60	33.38	46.00	-12.62	AVG	
8		2.1940	34.25	9.60	43.85	56.00	-12.15	QP	
9		6.6140	33.21	9.65	42.86	60.00	-17.14	QP	
10		6.6860	23.14	9.65	32.79	50.00	-17.21	AVG	
11		17.3380	17.74	9.71	27.45	50.00	-22.55	AVG	
12		19.2020	31.65	9.73	41.38	60.00	-18.62	QP	

*:Maximum data x:Over limit !:over margin

This report is issued by the company in accordance with the requirements of the "Conditions of Issuance of Test Reports" printed in the attached page. Unless otherwise stated, the results presented in this report only apply to the samples tested this time. Partial reproduction of this report is not allowed unless approved by the company in writing.

Guangzhou Depuhua Test Services Co. Ltd.

A301&A401, 3/F.&4/F., Xinghui Building, Guanqiao, Shilou, Panyu District, Guangzhou, Guangdong, China
Phone: +86 (0)20-6664 1688 Fax: +86 (0)20-6664 1699 Web://www.stsgz.com

e-mail: stsgz@stsapp.com



TEST REPORT

Report No.: STSGZ2310263030E

Date: 30-Nov-2023

Page 33 of 40

EUT:	Rechargeable torch including hand strap	M/N:	MO2137
Mode:	Charging+ON	Polarization:	Vertical
Test by:	Dawn	Power:	DC 5V by USB Port
Temperature: / Humidity	26.5°C/ 60.0%	Test date:	2023-10-27

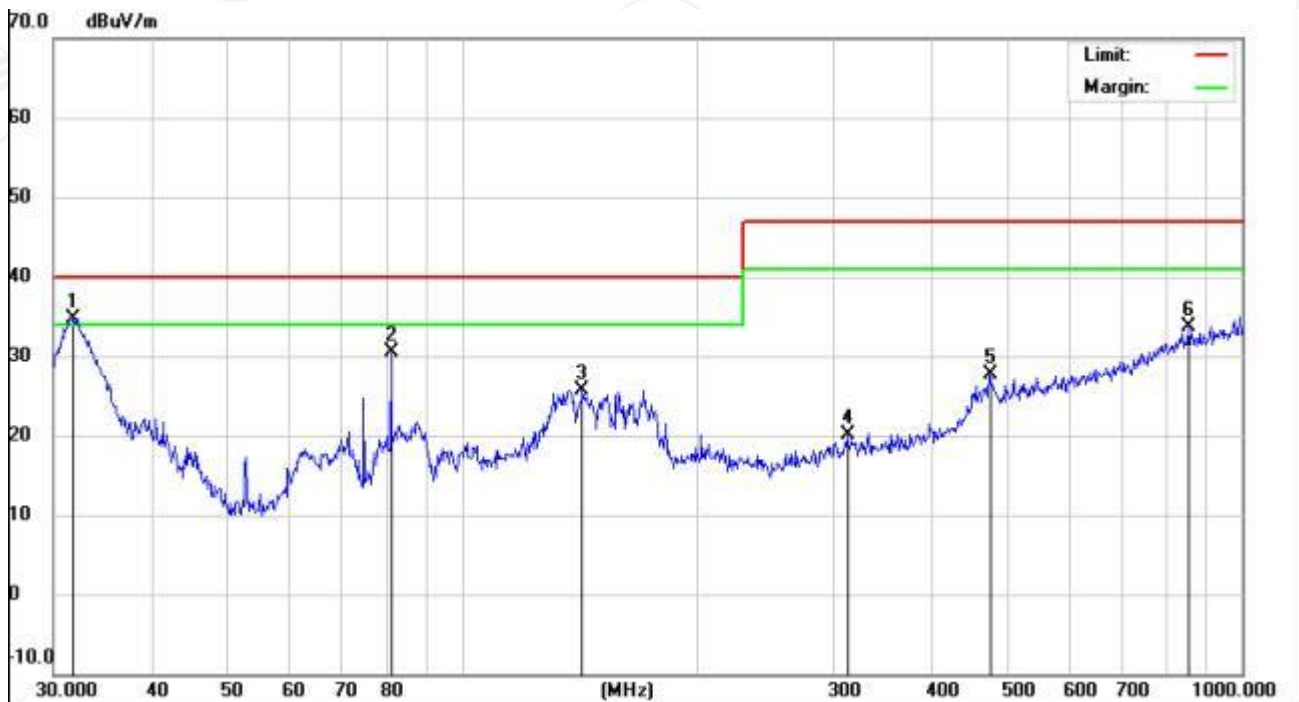

This report is issued by the company in accordance with the requirements of the "Conditions of Issuance of Test Reports" printed in the attached page. Unless otherwise stated, the results presented in this report only apply to the samples tested this time. Partial reproduction of this report is not allowed unless approved by the company in writing.

Guangzhou Depuhua Test Services Co. Ltd.

A301&A401, 3/F.&4/F., Xinghui Building, Guanqiao, Shilou, Panyu District, Guangzhou, Guangdong, China
Phone: +86 (0)20-6664 1688 Fax: +86 (0)20-6664 1699

Web://www.stsgz.com

e-mail: stsgz@stsapp.com



TEST REPORT

Report No.: STSGZ2310263030E

Date: 30-Nov-2023

Page 34 of 40

No.	Mk.	Freq.	Reading Level	Correct Factor	Measurement	Limit	Over	Antenna Height	Table Degree	
		MHz	dBuV	dB	dBuV/m	dBuV/m	dB	cm	degree	Comment
1	*	31.8427	15.13	19.65	34.78	40.00	-5.22	QP		
2		81.2117	20.49	10.08	30.57	40.00	-9.43	QP		
3		142.8243	9.00	16.77	25.77	40.00	-14.23	QP		
4		312.1794	4.46	15.73	20.19	47.00	-26.81	QP		
5		473.8347	6.32	21.31	27.63	47.00	-19.37	QP		
6		854.0247	5.14	28.49	33.63	47.00	-13.37	QP		

*:Maximum data x:Over limit !:over margin

This report is issued by the company in accordance with the requirements of the "Conditions of Issuance of Test Reports" printed in the attached page. Unless otherwise stated, the results presented in this report only apply to the samples tested this time. Partial reproduction of this report is not allowed unless approved by the company in writing.

Guangzhou Depuhua Test Services Co. Ltd.

A301&A401, 3/F.&4/F., Xinghui Building, Guanqiao, Shilou, Panyu District, Guangzhou, Guangdong, China
Phone: +86 (0)20-6664 1688 Fax: +86 (0)20-6664 1699

e-mail: stsgz@stsapp.com

Web://www.stsgz.com



TEST REPORT

Report No.: STSGZ2310263030E

Date: 30-Nov-2023

Page 35 of 40

EUT:	Rechargeable torch including hand strap	M/N:	MO2137
Mode:	Charging+ON	Polarization:	Horizontal
Test by:	Dawn	Power:	DC 5V by USB Port
Temperature: / Humidity	26.5°C/ 60.0%	Test date:	2023-10-27

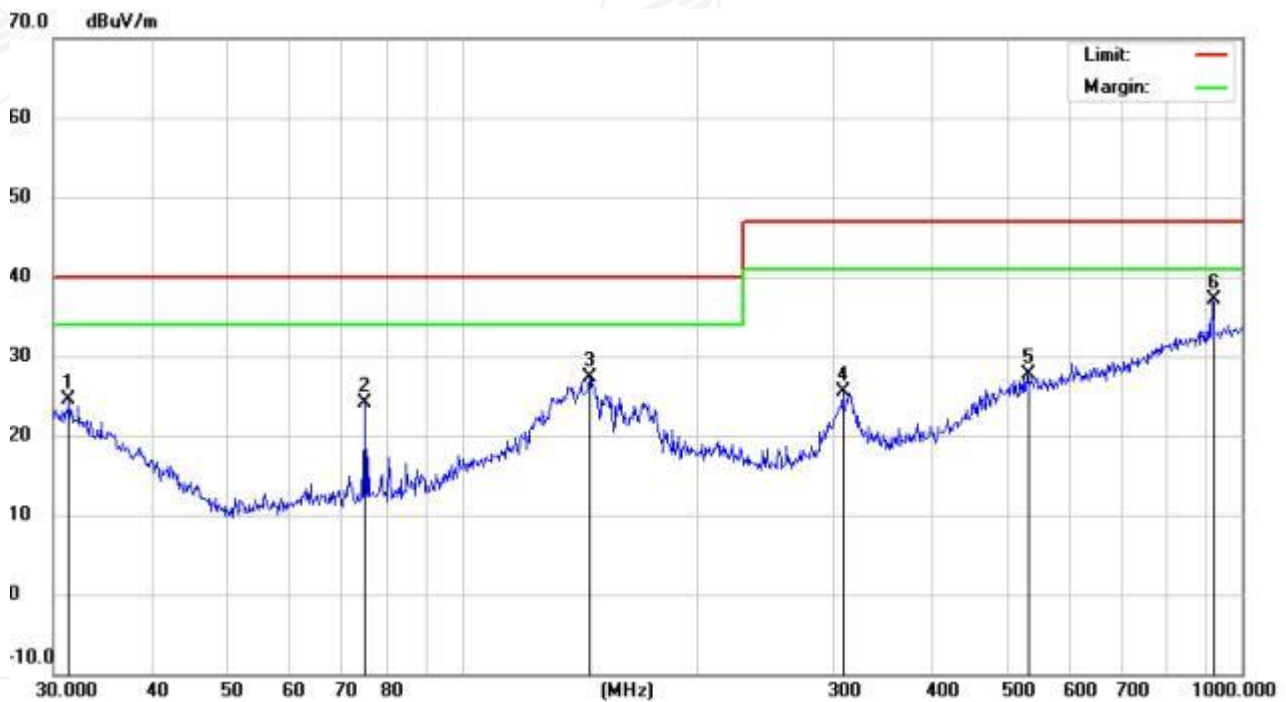

This report is issued by the company in accordance with the requirements of the "Conditions of Issuance of Test Reports" printed in the attached page. Unless otherwise stated, the results presented in this report only apply to the samples tested this time. Partial reproduction of this report is not allowed unless approved by the company in writing.

Guangzhou Depuhua Test Services Co. Ltd.

A301&A401, 3/F.&4/F., Xinghui Building, Guanqiao, Shilou, Panyu District, Guangzhou, Guangdong, China
Phone: +86 (0)20-6664 1688 Fax: +86 (0)20-6664 1699

Web://www.stsgz.com

e-mail: stsgz@stsapp.com



TEST REPORT

Report No.: STSGZ2310263030E

Date: 30-Nov-2023

Page 36 of 40

No.	Mk.	Freq.	Reading Level	Correct Factor	Measurement	Limit	Over	Antenna Height	Table Degree	
		MHz	dBuV	dB	dBuV/m	dBuV/m	dB	cm	degree	Comment
1		31.3992	4.49	19.95	24.44	40.00	-15.56	QP		
2		75.1822	14.39	9.71	24.10	40.00	-15.90	QP		
3		145.8611	10.20	17.16	27.36	40.00	-12.64	QP		
4		307.8313	9.90	15.65	25.55	47.00	-21.45	QP		
5		530.1014	4.64	23.03	27.67	47.00	-19.33	QP		
6	*	916.0687	7.97	29.16	37.13	47.00	-9.87	QP		

*:Maximum data x:Over limit !:over margin

This report is issued by the company in accordance with the requirements of the "Conditions of Issuance of Test Reports" printed in the attached page. Unless otherwise stated, the results presented in this report only apply to the samples tested this time. Partial reproduction of this report is not allowed unless approved by the company in writing.

Guangzhou Depuhua Test Services Co. Ltd.

A301&A401, 3/F.&4/F., Xinghui Building, Guanqiao, Shilou, Panyu District, Guangzhou, Guangdong, China
Phone: +86 (0)20-6664 1688 Fax: +86 (0)20-6664 1699

e-mail: stsgz@stsapp.com

Web://www.stsgz.com



TEST REPORT

Report No.: STSGZ2310263030E

Date: 30-Nov-2023

Page 37 of 40

Photo(s):



Test Sample Photo



Conducted Test Setup Photograph

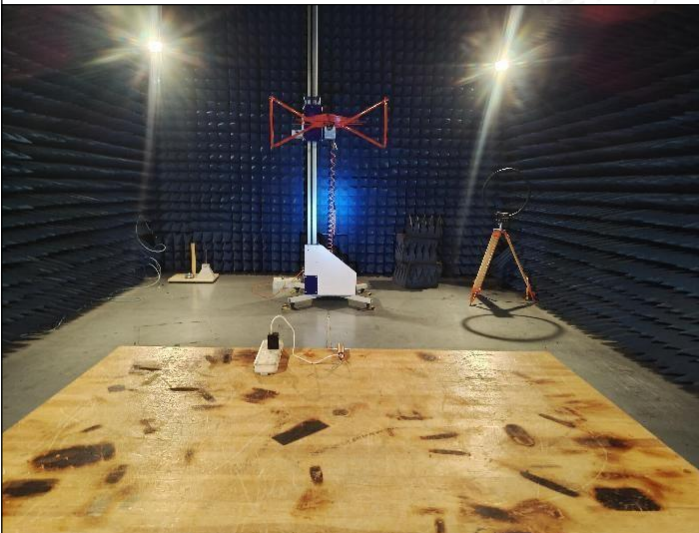

Radiated Test Setup Photograph



ESD Test Setup Photograph

This report is issued by the company in accordance with the requirements of the "Conditions of Issuance of Test Reports" printed in the attached page. Unless otherwise stated, the results presented in this report only apply to the samples tested this time. Partial reproduction of this report is not allowed unless approved by the company in writing.

Guangzhou Depuhua Test Services Co. Ltd.

A301&A401, 3/F.&4/F., Xinghui Building, Guanqiao, Shilou, Panyu District, Guangzhou, Guangdong, China
Phone: +86 (0)20-6664 1688 Fax: +86 (0)20-6664 1699

Web://www.stsgz.com

e-mail: stsgz@stsapp.com

TEST REPORT

Report No.: STSGZ2310263030E

Date: 30-Nov-2023

Page 38 of 40

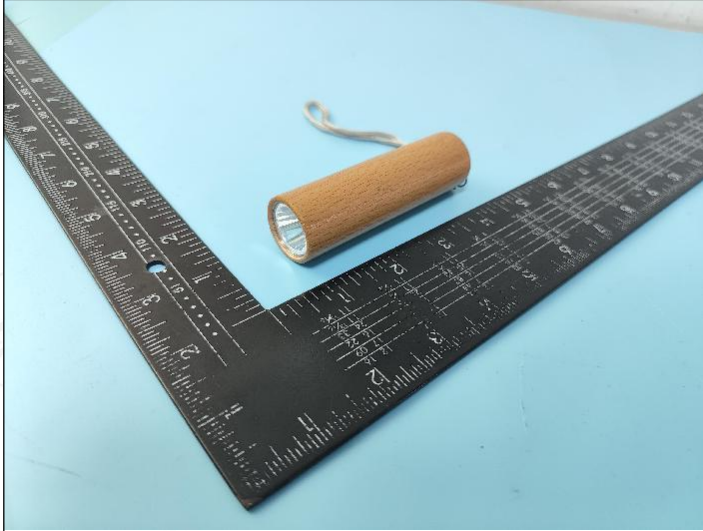

General Appearance of the EUT



General Appearance of the EUT

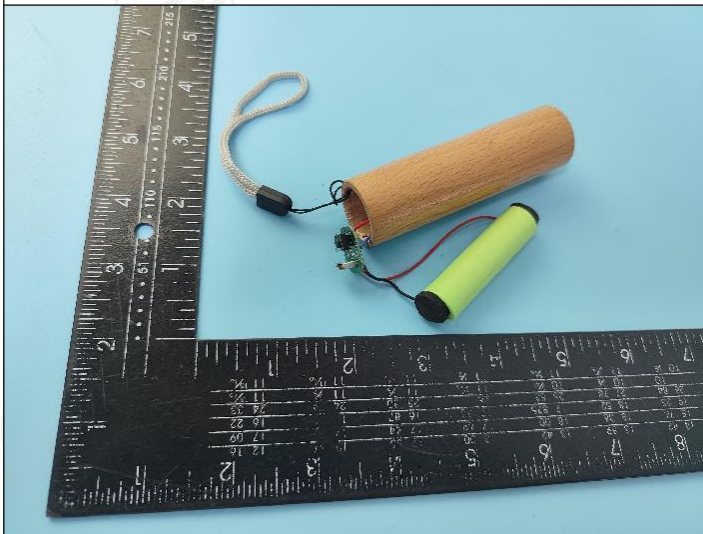

Internal of the EUT

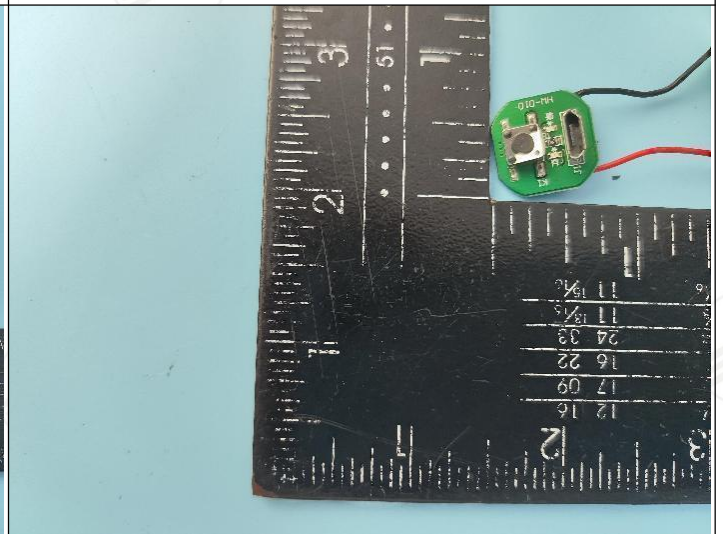

PCB of the EUT

This report is issued by the company in accordance with the requirements of the "Conditions of Issuance of Test Reports" printed in the attached page. Unless otherwise stated, the results presented in this report only apply to the samples tested this time. Partial reproduction of this report is not allowed unless approved by the company in writing.



TEST REPORT

Report No.: STSGZ2310263030E

Date: 30-Nov-2023

Page 39 of 40

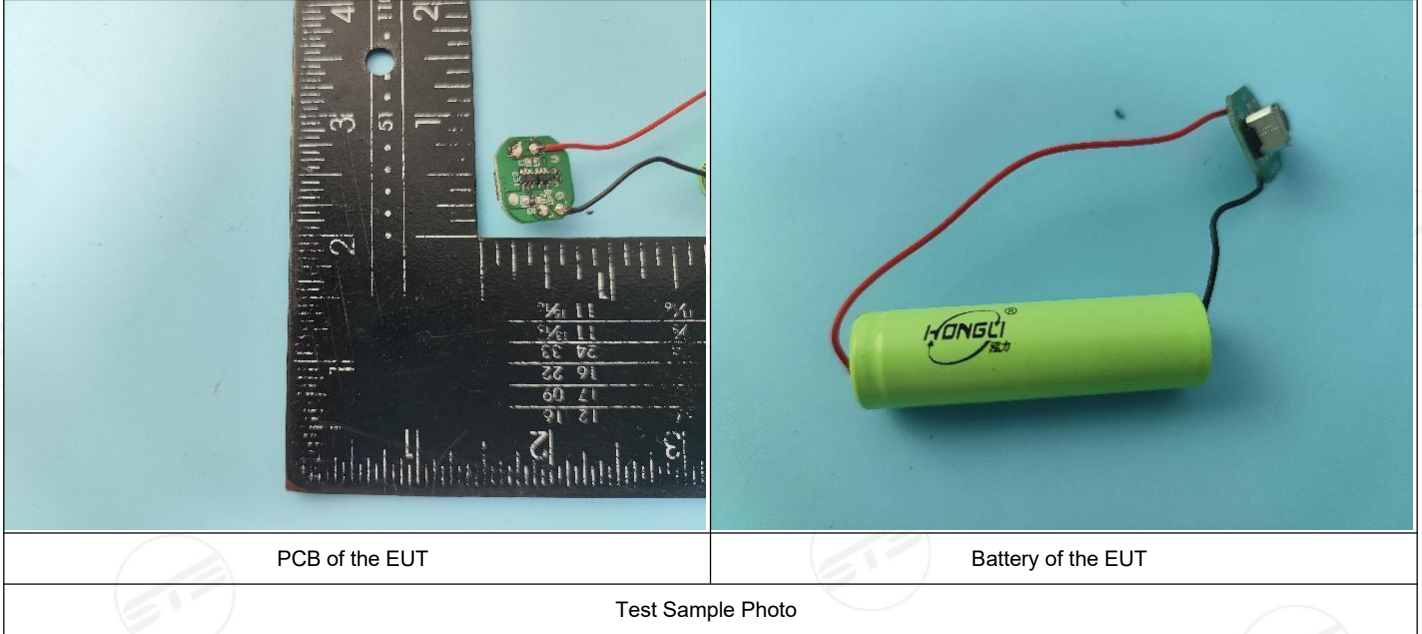

<<< <<< END OF REPORT >>> >>>

This report is issued by the company in accordance with the requirements of the "Conditions of Issuance of Test Reports" printed in the attached page. Unless otherwise stated, the results presented in this report only apply to the samples tested this time. Partial reproduction of this report is not allowed unless approved by the company in writing.

Guangzhou Depuhua Test Services Co. Ltd.

A301&A401, 3/F.&4/F., Xinghui Building, Guanqiao, Shilou, Panyu District, Guangzhou, Guangdong, China
Phone: +86 (0)20-6664 1688 Fax: +86 (0)20-6664 1699

Web://www.stsgz.com

e-mail: stsgz@stsapp.com



TEST REPORT

Report No.: STSGZ2310263030E

Date: 30-Nov-2023

Page 40 of 40

声明 Statement

- 本检测报告首页所列信息中除样品来源、接样日期、检测日期、检测结果和检测结论外，均由委托方提供，委托方对样品的代表性和资料的真实性负责，本实验室不承担任何相关责任。
The information as listed on the first page of this test report was all provided by the client except the sample from, date received, test period, test results and test conclusion. The client shall be responsible for the representativeness of sample and authenticity of materials, for which STS shall bear no responsibilities.
- 本检测报告以实测值进行符合性判定，未考虑不确定度所带来的风险，特别约定、标准或规范中有明确规定的除外。此种判定方式所带来的风险由客户自行承担，本实验室不承担相关责任。
The judgment method of determining the conformity in this test report is according to the measured value without considering the risk caused by uncertainty, unless otherwise clearly stipulated in special agreement, standard or specification. The client shall assume the risk caused by the judgment method, and STS shall not bear related responsibilities.
- 检测报告无批准人签字及“检验检测专用章”无效，未经本实验室书面同意，不得整体或部分复制本报告。
The test report is effective only with both signature and specialized stamp. Without written approval of STS, this report can't be reproduced in full or in part.
- 本检测报告的检测结果仅对送测样品负责，未加盖资质认定标志的检测报告不对社会具有公证证明作用，对于检测数据、结果的使用，所产生的直接或间接损失及一切法律后果，本实验室不承担任何经济和法律责任。
This test data is only responsible for the tested sample. The data and results provided by the report without CMA accreditation are not to prove to the society, and STS is not responsible for any economic and legal responsibility for the use of the test data, the direct or indirect losses resulting from the use of the test and all legal consequences.
- 本检测报告中检测项目标注有下划线则该项目不在本实验室资质认定能力范围内，该项目检测结果仅作为客户委托、科研、教学或内部质量控制等目的使用。
The underlined test item in the report is out of the scope of CMA accreditation. The test result only used for client's requirement, scientific researching ,teaching or internal quality control.
- 其它声明请查阅报告页脚及书面报告末页。
For other statements, please refer to the footer of the report.

This report is issued by the company in accordance with the requirements of the "Conditions of Issuance of Test Reports" printed in the attached page. Unless otherwise stated, the results presented in this report only apply to the samples tested this time. Partial reproduction of this report is not allowed unless approved by the company in writing.

Guangzhou Depuhua Test Services Co. Ltd.

A301&A401, 3/F.&4/F., Xinghui Building, Guanqiao, Shilou, Panyu District, Guangzhou, Guangdong, China
Phone: +86 (0)20-6664 1688 Fax: +86 (0)20-6664 1699

e-mail: stsgz@stsapp.com

Web://www.stsgz.com

签发测试报告条款

Conditions of Issuance of Test Reports

1. 广州市德普华检测技术有限公司(以下简称[公司])为提供符合下述条款的测试和报告,而接受有关样品和货品。本公司基于下述条款提供服务,下述条款为本公司与申请服务的个人、企业或公司(以下简称[客户])的协议。

All samples and goods are accepted by the Guangzhou Depuhua Test Services Co., Ltd. (the "Company") solely for testing and reporting in accordance with the following terms and conditions. The company provides its services on the basis that such terms and conditions constitute express agreement between the Company and any person, firm or company requesting its services (the "Clients").
2. 由此测试申请所发出的任何报告(以下简称[报告]),本公司会严格为客户保密。未经本公司的书面同意,报告的整体或部分不得复制,也不得用于广告或授权的其他用途。然而,客户可以将本公司印制的报告或认可的副本,向其客户、供货商或直接相关的其它人出示或提交。除非相关政府部门、法律或法规要求,否则未经客户同意,本公司不得将报告内容向任何第三方讨论或披露。

Any report issued by Company as a result of this application for testing services (the "Report") shall be issued in confidence to the Clients and the Report will be strictly treated as such by the Company. It may not be reproduced either in its entirety or in part and it may not be used for advertising or other unauthorized purposes without the written consent of the Company. The Clients to whom the Report is issued may, however, show or send it, or a certified copy thereof prepared by the Company to its customer, supplier or other persons directly concerned. The Company will not, without the consent of the Clients, enter into any discussion or correspondence with any third party concerning the contents of the Report, unless required by the relevant governmental authorities, laws or court order.
3. 除非相关政府部门、法律或法院要求,否则未经公司预先书面同意,本公司毋需,也并无义务到法院对有关报告作证。

The Company shall not be called or be liable to be called to give evidence or testimony on the Report in a court of law without its prior written consent, unless required by the relevant governmental authorities, laws or court orders.
4. 除非本公司进行抽样,并已在报告中说明,否则报告中适用于送测的样品(样品信息为客户提供),不适用于批量。

The Report refers only to the tested sample (Sample information is provided by customer) and does not apply to the bulk, unless the sampling has been carried out by the Company and is stated as such in the Report.
5. 如果本公司确定报告被不当地使用,本公司保留撤回报告的权利,并有权要求其它适当的额外赔偿。

In the event of the improper use of the report as determined by the Company, the Company reserves the right to withdraw it, and to adopt any other additional remedies which may be appropriate.
6. 本公司接受样品进行测试的前提是,该测试报告不能作为针对本公司法律行动的依据。

Samples submitted for testing are accepted on the understanding that the Report issued cannot form the basis of, or be the instrument for, any legal action against the Company.
7. 如因使用本公司中心任何报告内的资料,或任何传播信息所描述与之有关的测试或研究导致的任何损失或损害,本公司概不负责。

The Company will not be liable for or accept responsibility for any loss or damage however arising from the use of information contained in any of its Reports or in any communication whatsoever about its said tests or investigations.
8. 若需要在法院审理程序或者仲裁过程中使用测试报告,客户必须在提交测试样品前将该意图告知本公司。

Clients wishing to use the Report in court proceedings or arbitration shall inform the Company to that effect prior to submitting the sample for testing.
9. 该测试报告的支持数据和信息本公司保存 10 年。个别评审机构有特别要求的,检测数据和报告的保存期可依情况变动。一旦超过上述提交的保存期限,数据和信息将被处理掉。任何情况下,本公司不必提供任何被处理的过期数据或信息。即使本公司事先被告知可能会发生相关的损害,本公司在任何情况下也不必承担任何损害,包括(但不限于)补偿性赔偿、利润损失、数据遗失、或任何形式的特殊损害、附带损害、间接损害、从属损害或任何违反约定、违反承诺、侵权(包括疏忽)、产品责任或其他原因的惩罚性损害。

Subject to the variable length of retention time for test data and report stored hereinto as otherwise specifically required by individual accreditation authorities, the Company will only keep the supporting test data and information of the test report for a period of ten years. The data and information will be disposed of after the aforementioned retention period has elapsed. Under no circumstances shall we provide any data and information which has been disposed of after retention period. Under no circumstances shall we be liable for damage of any kind, including (but not limited to) compensatory damages, lost profits, lost data, or any form of special, incidental, indirect, consequential or punitive damages of any kind, whether based on breach of contract of warranty, tort (including negligence), product liability or otherwise, even if we are informed in advance of the possibility of such damages.
10. 报告的签发记录可通过登录 www.stsgz.com 查询。如需进一步查询报告有效性或核实报告,需与本公司联系。

Issuance records of the Report are available on the internet at www.stsgz.com. Further enquiry of validity or verification of the Report should be addressed to the company.